

Olsen VET

User's Manual Vet Cart



Olsen

*Manufacturing high quality
equipments for 40 years*



olsen.vet.br

 [olsen.vet](https://www.instagram.com/olsen.vet)

Index

Index	3
1 - Introduction	5
2 - Package Contents	5
3 - Equipment Presentation	5
3.1 - Standard Items	5
3.2 - Optional Items	5
4 - Parts Identification	7
5 - Equipment Description and Operating	7
5.1 - Before Turning On the Equipment	7
5.2 - Turning On the Equipment	7
5.3 - Base Structure	8
5.3.1 Air Compressor (Optional)	8
5.3.2 Air Tank Drainage	8
5.3.3 - Electrical Panel	8
5.3.4 - Pressure Regulator for Instruments	8
5.4 - Double Pedal	8
5.5 - Working Table	9
5.5.1 - Handpieces Arrangement on the Working Table	9
5.5.2 - Panels	10
5.6 - Pneumatic Handpiece Couplings	10
5.7 - Optical Fiber Handpiece (Optional)	11
5.8 - Prophylaxis System (Optional)	11
5.8.1 - Bicarbonate Jet	11
5.8.2 - Prophy-Jet (Optional)	11
5.8.3 - Bicarbonate Jet and Prophy-Jet Use Precautions	11
5.9 - Curing Light (Optional)	12
5.9.1 - Precautions on the Curing Light Use	12
5.10 - Ultrasonic Scaler with LED Light (Optional)	13
5.10.1 - Ultrasonic Scaler Tips	13
5.10.2 - Ultrasonic Scaler Operating Precautions	14
5.11 - Electrical Micromotor (Optional)	14
5.11.1 - Brushless Electric Micromotor (Optional)	15
5.12 - 3-Way Syringe (Optional)	16
5.13 - Venturi Saliva Ejector (Optional)	16
5.14 - Vórtive High Power Saliva Ejector (Optional)	16

5.15 - Vacuum Pump Adaptor (Optional).....	16
5.16 - Air Jet (Optional).....	17
5.17 - X-Ray Viewer.....	17
6 - General Features	17
6.1 - Valves	17
7 - Installation Requirements	17
7.1 - Pre-Installation	17
7.2 - Water for the Water Tank.....	18
7.3 - Electrical Installation.....	18
8 - Installation.....	18
8.1 - Check List.....	18
8.2 - Olsen Accredited Technical Assistance Network	19
9 - Cleaning and Disinfection.....	19
9.1 - Painted Parts.....	19
9.2 - Sterilization by Autoclave.....	19
9.3 - Curing Light	20
9.4 - Ultrasonic Scaler	20
9.5 - Saliva Ejectors and Solids Collector	20
9.6 - Daily Procedure at Working Day	20
10 - Technical Features	21
10.1 - Applied Parts.....	22
10.2 - Accessories and Detachable Parts	22
11 - Symbology.....	23
12 - Dimensional.....	25
13 - Important Notes.....	26
13.1 - General Cares - Compulsory Reading	26
13.2 - Disposal.....	27
13.3 - Transport and Storage.....	27
13.4 - Contraindications.....	27
13.4.1 - Contraindications on the Ultrasonic Scaler Use	27
13.4.2 Curing Light Contraindications	27
14 - Troubleshooting.....	28
15 - Preventive Review	29
16 - Registro de Revisão.....	30
17 - Warranty Terms	30
18 - Message from the President.....	31

1 - Introduction

Congratulations for the great choice!

You have acquired high-tech equipment developed to offer the best performance in veterinary procedures ensuring efficiency and safety for the professional and the patient.

The User Manual presents the descriptive and technical information, installation instructions, maintenance, cleaning, precautions for use and regulatory guidelines. So before starting the operation of the equipment read carefully its instructions.

2 - Package Contents

Check out the equipment package contents:



Standard Items:

- 1 Vet Cart
- 1 User Manual Vet Cart

Optional Items:

- Electrical Micromotor
- Brushless Electrical Micromotor
- Ultrasonic Scaler with LED Light
- LED Curing Light
- Prophy-Jet System

Note:

- 1 - Items availability in the packaging may change in the case of the customer order.
- 2 - Handpieces: Dental instruments acquired with the equipment described in the purchase order and invoice of the product, according to customer request.

3 - Equipment Presentation

3.1 - Standard Items

- Stainless Steel Tray
- Polyurethane Casters

3.2 - Optional Items

- Coupling for Low-speed with Cooling
- Midwest Coupling
- Coupling for Optical Fiber Handpiece
- Additional Handpiece Coupling
- Prophylaxis System with Bicarbonate Jet
- Prophy-Jet System
- Air Jet System
- Thermo Comfort System
- Coupling for Low-speed Handpiece without cooling
- Coupling for High-speed Handpiece
- 3-Way Syringe
- Instruments Water Tank with Solids Filter
- Venturi Saliva Ejector
- Pressure Regulator for Instruments
- Pressure Gauge for Air Tank
- Electrical Micromotor
- Brushless Electrical Micromotor
- Ultrasonic Scaler with LED Light
- LED Curing Light
- High Power Vórtice Saliva Ejector
- Vacuum Pump Adaptor Set
- X-Ray Viewer

4 - Parts Identification



- A** - Working Table
(Item 5.5 - pg. 9)
- B** - Electrical Panel
(Item 5.5.2 - pg. 10)
- C** - Control Panel
(Item 5.5.2 - pg. 10)
- D** - Water Tank
(Item 5.2 - pág. 7)
- E** - Base Structure
(Item 5.3.2 - pág. 8)
- F** - Progressive Foot Pedal
(Item 5.4 - pg. 8)

5 - Equipment Description and Operating

The cart system provides working table handpieces and accessories on a steel base with casters, which provides mobility for the professional.

It is equipped with air compressor (optional) to supply the compressed air needs of the pneumatic instruments and saliva ejector Venturi. Its air reservoir is the equipment's column.

Can be moved easily because it has high resistance casters built in molded polyurethane that protect the floor and have very low noise level in the displacement.

5.1 - Before Turning On the Equipment

- 1° - Check if the equipment is properly installed in accordance to the instructions in the *Chapter 7 (Installation Requirements)* of this manual;
- 2° - If it has sewage tank (2), check if is properly attached and without leaks;
- 3° - Turn On the equipment's power circuit breaker.

5.2 - Turning On the Equipment

- 1° - Turn On the On/Off switch (4);
- 2° - If it has compressor, close the pressure valve (1);
- 3° - Remove the water tank (3) and fill it with filtered and boiled drinking water, up to the indicated limit in the tank. Then put the tank to the platform. It is possible to use prophylactic products of low concentration;
- 4° - If it has compressor, open the pressure valve (1) and check if the water tank (3) is well attached and free of leaks;
- 5° - Before starting the use equipment, verify the operation of all instruments and commands available and perform the cleaning and sterilization of the instruments (*chapter 9 - Cleaning and Disinfection*) of this manual.

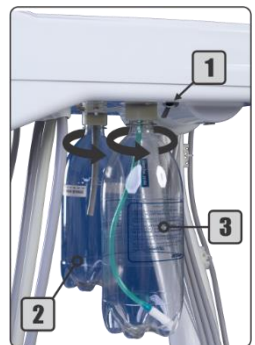

5.3 - Base Structure

5.3.1 Air Compressor (Optional)

The cart may come with a compact compressor (7) (optional) to supply the compressed air needs of the pneumatic instruments and saliva ejector.

The compressed air tank is the column and base (1) of the equipment, which has an electrical panel (4), manometer (2), drain (6) and safety valve (3).

The compressed air outlet has an pressure regulator for instruments with adjustment valve (5) that allows the reduction and cut off the airflow. For this adjustment, simply turn the valve clockwise to reduce or close the flow and counterclockwise to open.

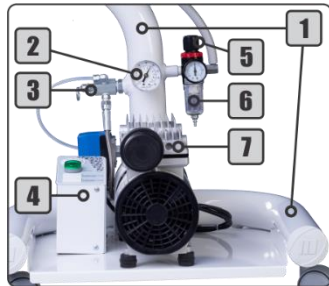

Reducing the airflow in the automatic drain adjustment valve can impair the performance of pneumatic and ejection instruments.

5.3.2 Air Tank Drainage

The air tank drain (8) is a preventive procedure, which avoids the moisture accumulation, the automatic drain clogging and consequently a drop in the performance of pneumatic and ejection instruments.

To drain the air tank: with the compressor turned Off and the air tank pressurized, open the air tank drain valve (8) by turning it counterclockwise. Leave the hose outlet free to let out the debris/water until the tank is clean.

Note: When the equipment remains On for a certain period, it is recommended to drain the tank daily.

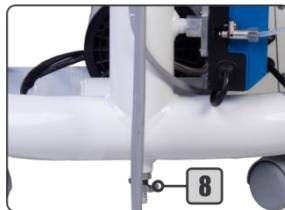

5.3.3 - Electrical Panel

4 - On/Off Switch

5 - Voltmeter

6 - Fuses



5.3.4 - Pressure Regulator for Instruments

The pressure regulator for instruments (6) has a filter for blocking the moisture of the compressed air and a pressure relief valve (5) to protect the equipment pneumatic system. It is installed on the equipment compressed air outlet.

Its function is to regulate the pressure supplied to the handpieces and to filter, to avoid dirt on the instruments

Automatic drainage occurs whenever the compressed air network is depressurized or reaches a pressure of less than 30 PSI, preventing the instruments from working properly.

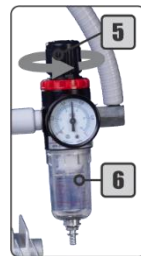

5.4 – Progressive Foot Pedal

The progressive foot pedal is used to drive the handpieces such as the micromotor, the high-speed handpiece, and the ultrasonic scaler.

When pressing the progressive valve, the higher the pressure on the pedal, the higher will be the handpiece rotation speed.

Note: for the ultrasonic scaler, the pedal only turns it On and Off.



5.5 - Working Table

- 1 - Electrical Panel;
- 2 - Control Panel;
- 3 - Instruments Holder;
- 4 - Bicarbonate Reservoir;
- 5 - Stainless Steel Tray;
- 6 - Fiber Optics/Air Jet On/Off Button;

The working table's function is to provide handpieces for performing veterinary procedures.

The handpieces are arranged in holders (3) and has composed of stainless-steel tray, 3-way syringe, and couplings for low and high-speed for pneumatic handpieces.

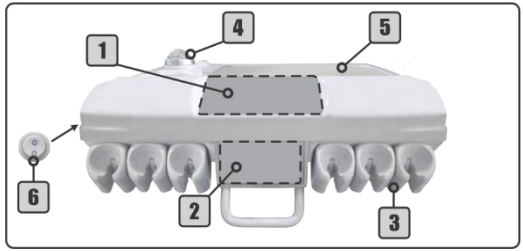

The layout of the controls may vary according customer order and available handpieces.

5.5.1 - Handpieces Arrangement on the Working Table

As standard, the working tables have the first pneumatic coupling from left to right for the low-speed handpiece/pneumatic micromotor (1) and the other couplings are for the high-speed handpieces (4).

The 3-Way Syringe (5) is placed on the last holder on the right.

This standard **does not apply** when the working table features built-in bicarbonate reservoir (3). In this case, the first pneumatic coupling is for the bicarbonate jet handpiece (2) and the second is for the low-speed handpiece (1). The other couplings are for the high-speed handpieces.



Note: Do not use high-speed handpieces on low-speed handpiece couplings. This will damage the handpieces.



5.5.2 - Panels

Command Panel Models

Standard



X-Ray Viewer

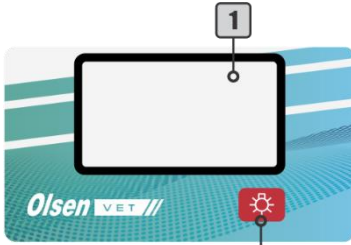

- 1 - X-Ray Viewer
- 2 - X-Ray Viewer On/Off Command

Instruments Control Panel:

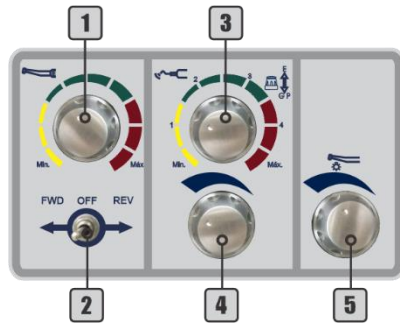

- 1 - Speed Adjustment for Electrical Micromotor
- 2 - Electrical Micromotor's Rotation Direction Control
- 3 - Ultrasonic Scaler Intensity Control and Endo Function Switch
- 4 - Ultrasonic Scaler Water Control
- 5 - Optical Fiber Water Control



Some functions indicated on control panel may not be available according to the equipment configuration (e.g.: endo function switch)

5.6 - Pneumatic Handpiece Couplings

As a standard, Olsen uses the Borden terminal system in its equipment, making the Midwest system available as an option.

The Borden coupling without cooling (1) is used only for the low-speed handpiece coupling.

The Borden refrigerated terminal (2) enables spray adjustment and is an optional item as well as the Midwest (3) terminal which is also cooled and has a propulsion air return system that does not return to the user's hand. These terminals do not have ledges or jambs, providing greater comfort to the user, and can be dismantled for cleaning without the use of specific tools.

The optical fiber handpiece coupling (4) is optionally supplied with special Midwest coupling with 3.1 V output for handpieces with optical fiber lighting.

Note: The pneumatic system is set to allow enough pressure for the activation of only one pneumatic handpiece at a time. If any handpiece is not properly seated in its holder, the propulsion air may partially activate this handpiece, impairing the equipment's performance.

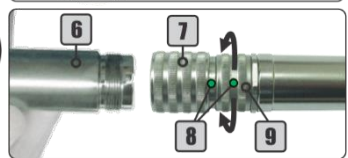

Operation instructions:

Connect the handpiece (6) to the coupling by attaching it to the coupling ring (7), ensuring that it is properly connected and that there is no leakage of air or water.

To activate the rotation: Press the progressive pedal (5). The higher the pressure applied to the button, the higher the rotational speed of the handpiece.

To adjust the spray: Turn the adjusting ring (9) until the desired volume of water. To adjust the maximum flow of water, bring the spray adjustment indicators (8) closer to each other. To decrease the flow of water, rotate

the ring so it distances one indicator from the other. The completely opposite points indicate the minimum water regulation for the spray.

Note: the spray adjustment is not available to pneumatic coupling without refrigeration.

5.7 - Optical Fiber Handpiece (Optional)

Connect the optical fiber handpiece to the coupling by attaching it to the coupling ring (1), ensuring that it is properly connected and that there is no leakage of air or water.

To activate the rotation: Press the progressive pedal (2). The higher the pressure applied to the progressive pedal, the higher the rotational speed of the handpiece.

To turn the coupling's light On/Off: Use the On/Off optical fiber light switch (3) on the command panel of the working table.

To adjust the spray: Use the optical fiber water control knob (4) on the instrument control panel.

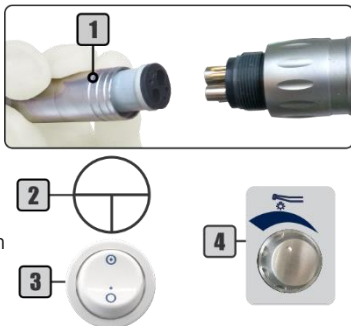

5.8 - Prophylaxis System (Optional)

5.8.1 - Bicarbonate Jet

Prophylaxis equipment by application of bicarbonate jet, located on the assistant module or on the working table. Besides the handpiece (2), it is equipped with a bicarbonate reservoir (3) with drains built-in.

The bicarbonate reservoir (4) has a red line that determines the limit for filling with sodium bicarbonate.

To activate/deactivate: Press the progressive pedal (1). The higher the pressure applied to the progressive pedal, the higher the air volume of the jet emitted by the bicarbonate jet.

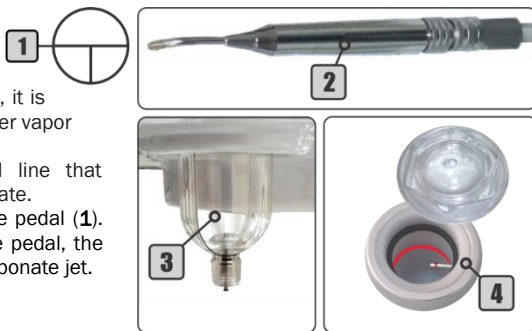

5.8.2 - Prophy-Jet (Optional)

Prophy-Jet (6) is a bicarbonate jet instrument with a built-in reservoir (7) and removable tip (5).

To use it, open the reservoir (7) and put bicarbonate up to the middle of the compartment (approximately 15 g). Close the reservoir and install it at the pneumatic micromotor coupling on the working table.

Before starting the Prophy-Jet (6) use, deposit up to 15g of sodium bicarbonate for dental use in the sodium bicarbonate reservoir (7) and attach the Prophy-Jet to the pneumatic coupling available on the pneumatic micromotor on the working table.

To activate/deactivate: Press the progressive pedal (1). The higher the pressure applied to the progressive pedal, the higher the air volume of the jet emitted by the Prophy-Jet.



Clean the sodium bicarbonate tank at the end of each procedure.

5.8.3 - Bicarbonate Jet and Prophy-Jet Use Precautions

- Do not fill bicarbonate reservoirs with more than the indicated amount. Excessive amounts of bicarbonate may impair the performance and function of the device;
- When handling sodium bicarbonate, keep the room ventilated and avoid powder inhalation, while filling the reservoir or using the bicarbonate jet. In the case of inhalation, go to a ventilated place;
- To reduce the risk of inhalation of bicarbonate mist use the Venturi saliva ejector or high power Vórtice saliva ejector when using the bicarbonate jet;
- Use only sodium bicarbonate for dental use, which can be purchased in any dental stores.

5.9 - Curing Light (Optional)

This tool was developed for polymerization and can be used for tooth bleaching. The curing light produces light radiation to solidify light sensitive resins with short duration shots.

Technical Features:

- Dimensions: 26 x 25 x 260 mm;
- Wave length: 420-480 nm;
- Net Weight: 135 g;
- Operation: Continuous, ramp and pulse;
- Light intensity with optical fiber tip: 1000 - 1200 mW/cm² (optical fiber tip).

This instrument has a 20 seconds timer for continuous use and protection mode to prevent overheating. If the curing lights triggered for several consecutive times without interval, the protection mode will be activated, locking the device for 20 seconds after each drive. To disable the protection mode, allow the device to stand for 4 minutes. The protection mode can be activated automatically from 9 successive starts.

The curing light uses a beep to indicate the following situations:

- 1 - Activation of Selection button;
- 2 - Activation of the ON/OFF button;
- 3 - After operation for 10 seconds;
- 4 - After operation for 20 seconds.

Before starting the curing light use, install the optical fiber tip (1) and the light hood (2).

To install the tip: first, attach the light hood (2) to the tip and then attach it to the curing light unit (3). The tip must be pushed all the way to the fitting end.

To activate/deactivate the curing light: Press the On/Off switch (5) twice. The activation LED (4) will light up. The curing light unit will run for 20 seconds and will turn Off automatically.

To toggle the operating mode: Each tap on the selection button (9) switches the operation mode. Press the selection button (9) until the orange LED indicates the desired mode.

The curing light operates in the following modes:

Continuous (6): LED on the maximum power for 20 seconds;

Ramp (7): LED activates at its minimum power, gradually increasing. In 5 seconds reaches its maximum power until the cycle of 20 seconds is finished;

Pulse (8): LED keeps blinking for 20 seconds.

5.9.1 - Precautions on the Curing Light Use

- Prohibited the use in patients who present biological reactions of sensitivity to light;
- Do not aim the light of the curing light directly at the eyes. The curing light produces optical radiation emitted by LED;
- Do not touch the tip directly on the curing material. This will prevent material adhering to the tip, impairing the device performance;
- Do not use the curing light without the light hood;
- The optical fiber tip should only be used on the teeth. Avoid touching the patient's gums, lips or skin;
- Use the curing light only on the teeth;
- After 40 seconds of continuous use, the tip end can reach 56° C;
- Consecutive activations of the curing light with optical fiber tip may cause the tip end to heat, reaching a maximum temperature of 68° C.

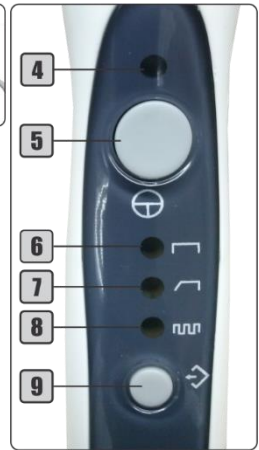
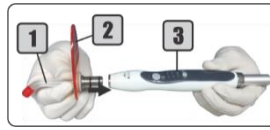

5.10 - Ultrasonic Scaler with LED Light (Optional)

The ultrasonic scaler has an ultrasonic generator electronic board that, through the Piezoelectric System, provides the tip vibration, giving a high-frequency condition. When the ultrasonic scaler is triggered, it starts the tip vibration, activates the LED and opens the water passage for cooling. Vibration power and water flow control for cooling can be adjusted through individual controls.

This handpiece was developed for use in dental applications, such as scarification, root planning, root canal treatment, cavity and periodontal preparation. These tips come with the ultrasonic scaler: GD1, PD1 and PD3.



Technical Features:

- Frequency: 28 KHz \pm 3 KHz;
- Power supply: 24 VCC;
- Output force (half-displacement): <2N;
- Power Rating: 3 to 20 W;
- Operation mode: Continuous;
- Tip vibration displacement: \leq 100 μ m.

For the ultrasonic scaler use it is necessary to connect the transducer (1) to the terminal (3) and install the ultrasonic tip on the transducer.

To attach the transducer to the terminal: Align the adjustment indicators (2) of the two parts and carefully insert them.

To install the scaler tips: Insert the tip into the transducer by threading it carefully, then insert the Torque wrench (4) into the tip and then rotate it clockwise until it is tight. To remove the tip, turn it counterclockwise with the Torque wrench.

After installing the tip, check for leakage between the transducer (1) and the terminal (3).

To install a file adapter (not supplied with the scaler): Attach the adapter to the transducer and screw it gently. Use the Endo wrench (5) to lock. Insert the file into the tip of the adapter, thread the tip and then use the Endo wrench (5) to tighten. To remove the adapter, use the Endo wrench to loosen it and then carefully unscrew.

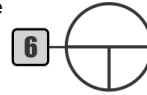

To activate the ultrasonic scaler: Press the progressive pedal (6).

To adjust the vibration power: Turn the control knob (7) until the desired power is reached.

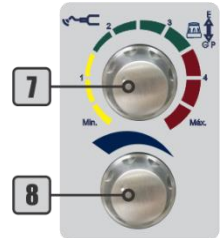

To toggle functions: Push the control knob (7) in direction of the table for "GP" function (General and Perio). Pull the knob gently in the opposite direction of the table for "E" (Endo) function (this function is not available to V2 Scaler without LED light).

To adjust the water flow: Turn the adjust knob (8) until the desired flow is reached.



The selection between General and Perio / Endo function is not available to V2 Scaler without LED light.

5.10.1 - Ultrasonic Scaler Tips

The tips GD1, PD1 and PD3 accompany the scaler. The power and application information for each tip is available in the table below.

Tip	Code	Function	Power	Indication of use
	GD1	G	1-10	Removal of calculus and plates in the supragingival, interdental and tooth surfaces.
	PD1	P	1-10	Removal of calculus subgingival
	PD3	P	1-6	Removal of deep calculus subgingival

Note:

- 1 - Do not use the tip on features other than those specified by the manufacturer.
- 2 - Do not exceed the power limit for each tip. That could damage the tip and the ultrasonic scaler.

5.10.2 - Ultrasonic Scaler Operating Precautions

- Check out the vibration outside the patient's oral cavity before use. If any abnormality is found, discontinue use immediately and contact a Certified Olsen Assistance;
- Always use gloves when handling the ultrasonic scaler, tips, Torque wrench and its removable covers;
- Use only the Torque wrench to fix and remove tips. If the tip is not fixed properly, it will present vibration loss;
- This ultrasonic scaler has been developed for professional dental use only and should not be used for any other purpose;
- The tip wears out with use, this can cause reduction of power. If this occurs, replace the tip;
- Do not sharpen or bend the tip. Tips can be damaged and do not generate enough vibration during scarification;
- While in use, the ultrasonic scaler system may affect computers and LAN cables. During an operation next to radio device, interference may be heard;
- Use only autoclave proper for dental use to sterilize tips, Torque wrenches, transducer and LED;
- Before installing any tip on the ultrasonic scaler, check its maximum intensity power. Using power above recommended will cause tip damage and ultrasonic scaler;
- Keep it away from patients with cardiac pacemakers or anesthetized;
- During the ultrasonic scaler use, the tip temperature may rise if the spray is not used. Always use enough spray water for the cooling of the handpiece and the teeth;
- Use the device only on the teeth. Contact with skin, gums and mucous membranes may cause injury;
- Keep the ultrasonic scaler away from explosives and flammable materials;
- Do not submit the handpiece to any strong impact, or drop it;
- Do not exceed the recommended intensity for the tip this may damage the tooth and tips;
- Do not use it on metal, or ceramic, porcelain or resin prostheses;
- Do not touch and do not wet the back of the transducer, where there are electrical connections to the power cord. This can result in electric shock;
- Do not force the ultrasonic scaler cable when remove it. This may cause disconnection.

5.11 - Electrical Micromotor (Optional)

The Olsen's electrical micromotor does not require a cooling system because it has a speed control and forward/reverse direction control.

Technical Features:

- Rotation: from 0 to 35.000 RPM;
- Torque: 270 g-cm;
- Power supply: 24 VCC;
- Max Power: 60 W.

Before starting the operation, connect the handpiece to the electrical micromotor (2).

To activate the rotation: Press the progressive pedal (1).

To adjust the speed: Turn the control knob (3) until the desired speed is reached.

To change the rotation direction: Use the rotation direction control (4).

FWD: Clockwise.

OFF: Off.

REV: Counterclockwise.

Note: To change the rotation direction, wait for the electrical micromotor to stop turning completely.



5.11.1 - Brushless Electric Micromotor (Optional)

Technical Features:

- **Power Supply:** 24 VCA;
- **Power Rating:** ~33 W.
- **Rotation Speed:**
 - a) 20:1 from 100 to 2.000 rpm;
 - b) 1:1 from 2.000 rpm to 40.000 rpm;
 - c) 1:5 from 10.000 to 200.000 rpm;
- **Torque:** ~3,5 Ncm;
- **LED:** 25.000 Lux.

Before starting the operation, connect the handpiece to the electrical micromotor (15).

To activate the rotation: press the propulsion/activation pedal (section 5.5) or the Manual Start key (11). The On/Off indicator (2) will turn blue.

To select a preset program: use the Program key (8). There is 7 programs available, according the table below:

Program	Default settings
P1 My favorite1	
P2 My favorite2	
P3 Tooth prep (H)	1:5 200.000 rpm
P4 Tooth prep (L)	1:5 20.000 rpm
P5 Contra angle	1:1 40.000 rpm
P6 Straight	1:1 40.000 rpm
P7 Polishing	1:1 5.000 rpm

Gear ratio	Speed range (rpm)
1:5	10.000 - 200.000
1:1	2.000 - 40.000
4:1	500 - 10.000
10:1	200 - 4.000
16:1	100 - 2500
20:1	100 - 2000

SETUP Press **S** to select item
Press **▲**/**▼** to set the parameter

10S	Min 0,10 Mpa
ON/OFF	Max 0,40 Mpa

To adjust pneumatic activation mode: use the adjustment keys (13) to set the parameter. The selected pneumatic activation method is shown on the display (6).

ADJUST	ON/OFF
Micromotor performs speed according to the pressure on the pedal	When pedal is pressed micromotor performs the maximum speed

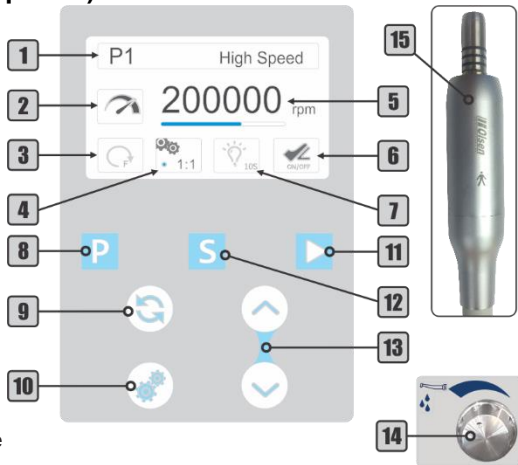

The selected program is shown on the display (1).

To record program: select program P1 or P2, then select the desired gear ration and adjust the speed. Press and hold the Program key (8) until the confirmation of the system.

To adjust speed: use the adjustment keys (13) to increase or decrease speed. Please see the table below for speed range for each gear ration value.

The selected speed is shown on the display (5).

To select the gear ratio: use Gear Ratio key (10). There are the following values available: 1:5, 1:1, 4:1, 10:1, 16:1 and 20:1.

The selected gear ratio is shown on the display (4).

To change the rotation direction: use the Direction key (9). The selected direction is shown on the display (3).



Forward



Reverse

To adjust the micromotor water: use the water control knob (15) on the instruments control panel.

To access setup menu: press and hold the Setting key (12).

Use the Setting key (12) to select the desired option.

To adjust LED options: use the adjustment keys (13) to set the parameter.

off	0S	10S
LED	LED On without	LED On with 10s

To adjust input pneumatic pressure: use the adjustment keys (13) to set the parameter.

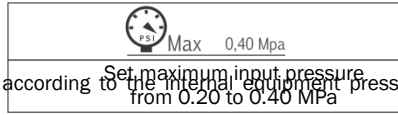
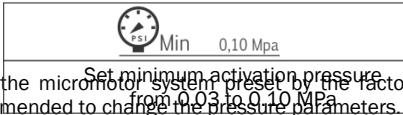

Note: the micromotor system preset by the factory according to the internal equipment pressure. It is not recommended to change the pressure parameters.

5.12 - 3-Way Syringe (Optional)

Before beginning the use of the 3-way syringe (5), connect the syringe tip (3) by pressing the locking ring (4) into the correct fit.

To emit air jet: Press the Air button (1).

To emit water: Press the Water button (2).

To emit spray jet: Press simultaneously the Water and Air buttons.

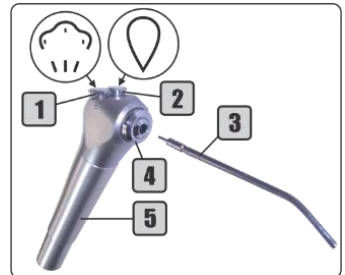

5.13 - Venturi Saliva Ejector (Optional)

The Venturi device (1) uses the compressed air from the air compressor to generate suction. It allows the coupling of Ø6,5 mm and Ø9,5 mm cannulas through the cannula adapters (3) and has a solids collector (2) to contain solid debris.

As an optional item can be installed to the Venturi saliva ejector's hose a quick hitch (4) for an easier removal for cleaning.

Note: The quick hitch is an optional item that can be installed to any hoses of the Venturi and Vórtice ejectors.

To activate the suction: Remove the ejector (2) from the holder (1).

To deactivate the suction: Place the ejector (2) in its holder (1).

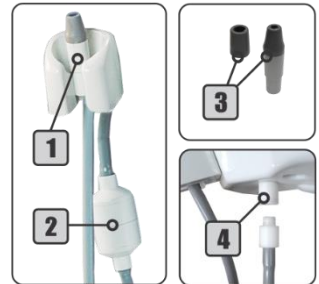

5.14 - Vórtive High Power Saliva Ejector (Optional)

The Vórtice high power saliva ejector is a device that uses the Venturi saliva ejector system, but its volume capacity is superior to that of the Venturi, reaching up to 385 mm/Hg.

The Vórtice high power saliva ejector may be used for suctioning in minor surgical and prophylaxis procedures.

To enable/disable suction of the Vórtice saliva ejector (2): use the On/Off button (1).

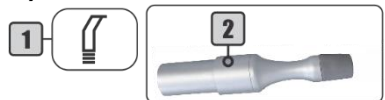

5.15 - Vacuum Pump Adaptor (Optional)

This item enables the use of the vacuum pump as a suction device. The suction holder is provided with a device for automatic ignition and shutdown of the pump. Furthermore, the handpiece has suction flow control and adapters for use with Ø9,5 mm. The adapter tip is cannula removable (1), allowing the use of cannulas of Ø11 mm.

To activate suction: Remove the vacuum pump suction (2) from its holder (2).

To adjust suction flow: To decrease the suction flow, turn adaptor's body (3), where the blue dots (4) alignment indicates the total opening of the ejection and, the opposite points indicate the closing of ejection.

To deactivate the suction: Place the vacuum pump in its holder (2). The vacuum pump and cannulas do not come with this device.

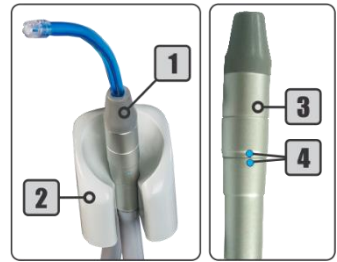

5.16 - Air Jet (Optional)

The Air Jet system provides agility in procedures with a high-speed turbine. It consists of continuous air jet through the turbine itself, eliminating the use of a syringe for this function.

Activation through command at the working table.

To activate/deactivate the Air Jet system: press the button (1) on the left side of the working table (Air Jet and fiber optic are thrown together).



5.17 - X-Ray Viewer

The x-ray viewer is an LED illumination display, that allows you to view x-rays without the need to move away from the patient.

To turn the X-ray viewer, press the On/Off button (1)



6 - General Features

- **Mechanical structure:** Manufactured in SAE 1020 rolled steel profiles and welded by MIG process, to guarantee the strength and durability;
- **Electrostatic painting:** It is applied to all structural metal parts of the equipment. The special polyurethane paint provides the equipment with high durability coating and has antibacterial properties according to JIS Z 2801: 2000, where in 24 hours, the bacterial reduction is greater than 99.9%.
- **Plastic covers:** Made of high-strength ABS with acrylic cover, the fairings do not require painting and allow polishing;
- **Electrical system:** The equipment can work in frequencies of 50 or 60 Hz and can be configured to be connected to the voltages of 127/220 Volts by an authorized technician. The maximum supply voltage of electronic boards, motors, and other controls is 24 V. The electrical system has On/Off switch, and protection fuses;
- **Handpiece holders:** Built in ABS, they have vanes to activate the valve of the holder, which interrupts the operation of the instrument when it is placed in its respective holder.

6.1 - Valves

The valves used in the equipment's hydro-pneumatic system have been developed to ensure its performance and durability, built in nonferrous metal with chromium coating.

- **Command valves:** Releases spray to the pneumatic handpiece, with a piston system to achieve stagnation and non-retraction of water;
- **Pressure regulating valves:** Guarantee the stability of propulsion pressure of the instruments, also allowing the adjustment according to the specifications of the handpieces. The factory setting is 2,2 bar of air pressure and regulated flow of 35 to 55 Liters of air per minute;
- **Handpiece holder valves:** Also called pilot valves, they release or interrupt the propulsion air to the handpiece when it is removed from the holder.

7 - Installation Requirements

7.1 - Pre-Installation

The pre-installation is the suitability of the environment for the installation of the equipment. This step should be guided by Olsen authorized assistance to ensure that the installation environment is suitable to receive

the new equipment. In this step should be prepared all water, compressed air, sewage tank, power supply and other accessories that will interact with the equipment.

Note: This equipment is not designed to be installed or operated in a surgical center.

7.2 - Water for the Water Tank

The ideal pressure for the equipment water supply is 2.8 to 6.0 bar.

The recommended pH (Potential of Hydrogen) is between 6.5 and 8.

The water used in the tank must be filtered and potable. It is recommended to use mineral water, which can easily be obtained in any market, but also can use public water, provided it is filtered and boiled, to avoid possible debris in the water causing valves clogging.

7.3 - Electrical Installation

The power grid must be single-phase, has specific grounding and exclusive 10 A/30 mA DR circuit breaker. The circuit breaker must only supply the dental equipment and must be easy and quick to disconnect from the mains.

If the power grid presents voltage variation, the installation of a surge protection device is required. There is a table below for sizing the electrical installation:

Voltage (V)	Cable Size (mm ²)	Distance (m)	Electric Current (A)
127/220	2,5	Up to 20	10



Before turning on the equipment make sure that the electrical voltage of the equipment is the same voltage as the power grid. There is a risk of damage to the equipment!



The contact with clean and filtered water offers no known risk to the user or the patient, but the use of sanitized gloves is recommended to fill the tanks and avoid cross-contamination.



This equipment should only be connected to a power source with protective grounding. There is an electric shock risk.



Do not place the equipment on a place that makes it difficult to disconnect it from the power grid.



Do not connect this equipment to a power grid without a 30 mA DR circuit breaker.



An authorized technician should make the installation. Installation performed by an unauthorized person will result in warranty loss.



Do not connect any other equipment on the cart equipment's exclusive power supply.

8 - Installation

The installation consists of equipment assembling and installation of its supply connections, such as water, compressed air, sewage (drainage and vacuum when available) and electricity.

When assembling the equipment, the technician should make the pressure adjustment of the terminals for pneumatic turbines, adjustment of the water pressure and air of the syringe and spray of pneumatic instruments, among other activities.

The equipment installation must be performed by Olsen certified technician, who will also inspect the equipment making sure it's according to what was requested, if it remains intact after having been transported, in addition, to performing a quality inspection before use, ending the process with a guidance on proper equipment operation, cleaning, and maintenance.

8.1 - Check List

The list below is intended to provide, in summary, important details to be checked regarding the equipment reception, installation environment preparation, appropriate supplies conditions and its correct installation.

We recommend that the equipment's owner accompanies the technician during this Check List so that, if necessary, he can arrange the necessary items to guarantee the correct equipment's installation.

- 1 - Is the handpieces pressure supply adequate (2,8 to 6,0 bar)?
- 2 - Is the power supply in accordance with *section 7.3 (Electrical Installation)*, with proper wiring and grounding for the equipment?
- 3 - Is there an adequate circuit breaker for equipment protection, in accordance with the *section 7.3 (Electrical Installation)* of this manual?
- 4 - The supply voltage must be 127/220 V with a $\pm 10\%$ tolerance. Was a surge protector installed to supply the equipment in case the voltage exceeded the tolerance?
- 5 - Is the air pressure on the equipment tank between 4,5 and 7,0 bar (60 and 100 PSI)?
- 6 - Does the compressor turn On and Off when performing its cycles?
- 7 - Did the equipment arrived as ordered and was delivered in perfect condition?
- 8 - Have the castors movements been checked?

8.2 - Olsen Accredited Technical Assistance Network

To access the Olsen certified technical assistance network for installation and maintenance or contact us by e-mail export3@olsen.odo.br or if you prefer +55 48 2106 6000.



Installation should be made only by an authorized technician. Installation performed by an unauthorized person will result in loss of warranty.

9 - Cleaning and Disinfection



The whole sanitize process must be done with the use of gloves suitable for cleaning and protection, in addition to a mask and protective glasses, according to biosafety standards.



All equipment items mentioned in this chapter must be sanitized and sterilized (when appropriate) prior to use.



Before starting to clean the equipment, turn off the power supply and keep the ambience clean.



This equipment does not have a water sterilization system. To ensure that the equipment sterilization does not affect water quality, the instruments, the syringe tip and its body, must be sterilized after each use.

9.1 - Painted Parts

It must be cleaned with a slightly damp cloth containing only soap or mild detergent.



Never use hypochlorite or alcohol-based products.

9.2 - Sterilization by Autoclave

Prior to autoclaving, clean the items, removing any organic residue, both from the surface and internal ducts (if any). Then carefully dry each item, including the internal ducts, if possible, with compressed air.

Note: Do not use any type of oil on the items to perform autoclaving.

Individually pack each item, with its own sterilized packaging for the autoclaving process. For steam autoclaving, the following values may be used (sterilization in accordance with *ISO 17665*):

- a) 130° C, 2 bars, 15 min;
- b) 120° C, 1 bar, 30 min;
- c) 134° C, 2,2 bars, 4 min.

The following equipment's items are autoclavable:

- Stainless steel trays;
- 3-way syringe's tip;
- Bicarbonate jet handpiece;
- Detachable Prophy-Jet tip;
- Vórtice saliva ejector cannula;
- Ultrasonic scaler/Torque and Endo wrench;
- Ultrasonic scaler/LED and transducer;
- Curing light/optical fiber tip;
- Electrical micromotor Brushless.

Note: The ultrasonic scaler transducer cannot be autoclaved in contact with other materials. The same applies to the bicarbonate jet handpiece and electrical micromotor Brushless.

To sterilize the ultrasonic scaler tips, set the autoclave to 132° C for 3 to 6 minutes at a pressure of 30 PSI (2 bar) or as indicated on ISO 17665 standard.

Regarding the resistance to the autoclaving process, the following items support:

Up to 1000 cycles: ultrasonic scaler tip and Torque wrench, stainless steel tray, 3-way syringe tip, Vórtice saliva ejector/cannula, and optical fiber curing light tip and electrical micromotor Brushless;

Up to 600 cycles: ultrasonic scaler transducer, bicarbonate jet handpiece and Prophy-Jet removable tip.

9.3 - Curing Light

To clean and disinfect the curing light tips, use gauze or disposable wipe moistened with soap and neutral detergent. Do not use alcohol, strong or abrasive alkaline detergents, detergents based on bleach, acetone, or other germicides.

The whitening tip cannot be autoclaved.

Curing light's body cleaning must be done with neutral detergent or 70% alcohol.



Olsen is not responsible for defects, deformities, spots on or abnormalities caused by improper use of chemical products, contact with tissues, leather, disposable gloves, inks, pigmented detergents and other organic or synthetic products.

9.4 - Ultrasonic Scaler

The transducer (5), the LED (3), the tips, Torque and Endo wrenches must be autoclaved for sterilization, as instructed in section 9.2 (Sterilization by Autoclave).

Prior to the transducer sterilization, remove the tip (if it is attached), the LED removable cover (1), the light driver (2) and the finishing ring (3). These items should be sterilized with 70% alcohol.

For proper functioning of the ultrasonic scaler, the LED must be correctly inserted in the transducer matching the LED's positive pole with the transducer's positive pole.

Use only autoclave for sterilization of tips, Torque and Endo wrenches, transducer and LED.

The following methods of sterilization are forbidden:

- Put in boiling water;
- Heat in stove, oven or microwave;
- Soak in disinfectants such as iodine, alcohol or glutaraldehyde.

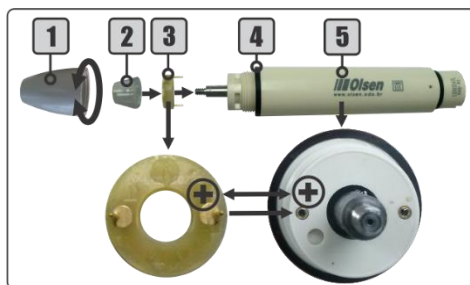

9.5 - Saliva Ejectors and Solids Collector

Daily disinfect the saliva ejector's hoses with an appropriate disinfection product for PVC hoses. It is essential to read the instructions of the asepsis product to avoid misuse or overdosage, which can cause damage to the medium and long term to the hoses. Using a proper concentration of the cleaning product, suck up with the suction needed for the effectiveness of the process. With the product still in the hose, place the suction on the hose holder. After the necessary action period of the product, suck 1 L of water.

The solids collector must also be cleaned daily. The saliva ejectors efficiency may be impaired if this filter is clogged. In the case of saliva ejector's performance reduction, clean its filters.

To clean the filters, follow the instructions below:

- 1° - Undo the solids collector cover (1);
- 2° - Remove the solids collector (2) for cleaning;
- 3° - After cleaning, re-assemble the solids collector cover (1).

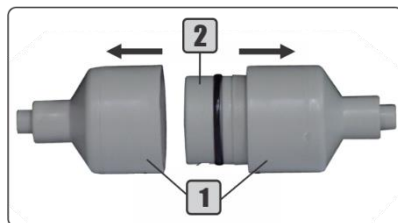

9.6 - Daily Procedure at Working Day

At the end of the working day, observe the following instructions:

- Turn Off the equipment and empty the air tank;
- Provide the equipment cleaning by cleaning the ejectors and their hoses and if necessary clean the plastic

- covers and metal parts;
- Remove the handpieces that were used during the day (high and low-speed) and provide their lubrication. After the lubrication, sterilize them;
- Remove the other handpieces used during the day: prophylaxis handpiece, 3-way syringe tip, the transducer and its tips, curing light tips and provide the sterilization of each one;
- Remove the water from the tanks and the bicarbonate of the prophylaxis reservoir;
- Turn the equipment On/Off switch Off;
- Turn Off the electrical circuit breaker that powers the equipment.
- Follow the instructions in *chapter 9 (Cleaning and Disinfection)* of this manual for equipment proper cleaning and its parts.

10 - Technical Features

Power supply: 127/220 V~;

A certified technician when installing the equipment must select the voltage;

Note: All equipment is factory set to 220 VC.



The equipment voltage must be selected when ordering.

Number of phases: Single Phase;

Frequency: 50/60 Hz;

Power rating:

- For 127 V: 200 VA;
- For 220 V: 250 VA;
- Air compressor: 1200 VA.

Protection fuses:

- Phase and Neutral: For 220 V~: F 0,5 A H (5 x 20 mm) fuse
For 127 V~: F 1,0 A H (5 x 20 mm) fuse
- Air Compressor: F 15 A H (5 x 20 mm) fuse

Electrical shock protection type (IEC 60601-1-1 and IEC 60601-1-2 standards): I Class

Protection degree:

B type parts: equipment;

BF type parts: ultrasonic scaler.

Operation mode:

Non-continuous operation: Curing light: Time On: 40 s; Time Off: 5 min.

Continuous operation: Thermo Comfort system, ultrasonic scaler, optical fiber coupling lighting, x-ray viewer and electrical micromotor.

Operating environment conditions:

Temperature: between 0° C and 28° C;

Pressure: 75 kPa ~ 106 kPa;

Relative Humidity: 30% ~ 70% non-condensing.

Harmful water penetration's protection:

Equipment: IPX0;

Pedal: IPX1

Thermal protection of the transformer: aperture with 130° C ± 3%.

Water tank capacity: 1000 ml;

Air tank capacity: 4,76 L;

Electrical Connection: ¾ flexible conduit.

Color of Internal Hoses:

Blue: air;

Green: water;

Translucent: sewage.

Weight:

- Net: 28,5 kg;
- Gross: 38 Kg.

Items in compliance with requirements 6.1 and 6.2 of IEC 60601-1-2:2010:**Power cable:**

Flexible Cable PP Circular 500 V 3 x 1 mm 247-5 NM 53-C5;
Tri-polar Male Plug 10 A - 250 V.

Ultrasonic scaler transducer:

Manufacturer: Guilin Woodpecker Medical Handpiece Co;
Model: UDS-N3 LED.

10.1 - Applied Parts

Standard Items:

Ultrasonic scaler with LED light;
Bicarbonate jet handpiece;
3-way syringe;
Curing light;
Venturi saliva ejector.

Optional Items:

Vacuum pump ejector;
Vórtice ejector/handpiece;
Electrical micromotor;
Low-speed handpieces;
High-speed handpieces

10.2 - Accessories and Detachable Parts

Detachable Parts:

Optical fiber tip for curing light;
Curing light acrylic tip;
Light hood for curing light;
Ultrasonic scaler tips;
Ultrasonic scaler transducer;
Bicarbonate jet handpiece;
Bicarbonate reservoir cover;
3-way syringe tip;
Water tanks;
Venturi saliva ejector;
Stainless steel tray;
Electrical micromotor;

Accessories:

Low-speed handpieces;
High-speed handpieces.

11 - Symbology

The symbology complies with standards IEC 60601-1 and IEC 60878.

	Multifunction Syringe (Air-Water)		Dental Air Motor		Turbine
	Turbina Pneumática com Iluminação		Micromotor Elétrico		Ultrassom
	Turbine with Illumination		Saliva Ejector		Suction Handpiece
	Spray-cooling		Variability, for Rotating Movement		Hand Control Valve
	Lighting		Progressive Pedal		Manufacturer
	"OFF" (Power)		"ON" (Power)		General Warning Sign
	Non Sterile		Caution		General Mandatory Action Sign
	Warning, Electricity		Level		Refer to the Instruction Manual
	Operating Instructions		General Prohibition Sign		Type BF Applied Part
	Stepping Prohibited		Type B Applied Part		Aterramento de Proteção
	Esterilizável até a Temperatura Especificada		Serial Number		Humidity Limitation
	Earth (Ground)		Keep Away from Heat		Keep Dry
	Fragile, Handle with Care		Temperature Limitation		Alternating Current
	Heaping Up		This Side Up		

EC	REP	Authorized Representative in the European Community
-----------	------------	-----------------------------------------------------

12 - Dimensional

Measurements in mm

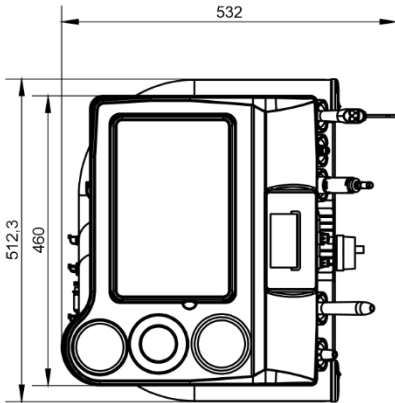
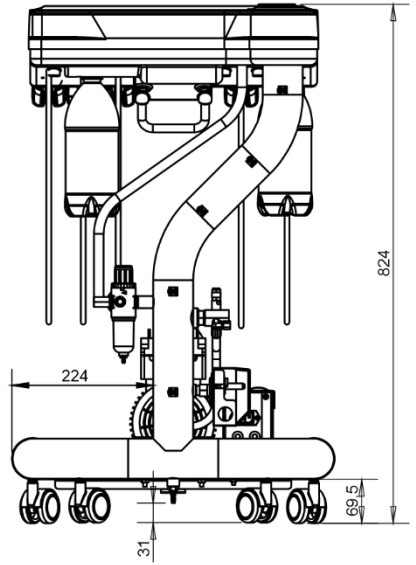
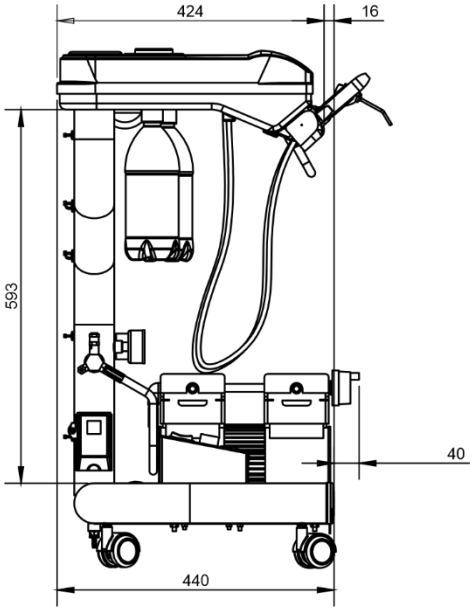

13 - Important Notes

The reproduction and distribution of these instructions can only be made with prior permission from Olsen Indústria e Comércio S.A.

The technical features of the products described in this manual correspond to the time of its publication. Future technical improvements do not result in any right to update existing products.

The images presented in this manual are illustrative.

This equipment is designed to be free from interference from magnetic fields, external electrical influences, electrostatic discharges, pressure or pressure variation, provided that the equipment is transported, installed, operated and sanitized in accordance with the instructions for use contained in this manual.

Hydropneumatics diagrams, electrical diagrams, installation instructions, components grid or any other technical information necessary to installation and maintenance of Olsen Vet Kart Premium will be disponible by request, by our e-mail: export3@olsen.odo.br or by telephone: +55 48 2106-6000.

13.1 - General Cares - Compulsory Reading



Follow the instructions in **Chapter 7** of this manual (*Installation Requirements*) to suit the electrical and hydraulic network where the equipment will be installed.



Follow instructions for proper use of the equipment and its accessories as described of this manual. Improper use could be harmful to equipment, which would not be covered by warranty.



Clean the equipment according to the instructions in **chapter 9** (*Cleaning and Disinfection*) of this manual.



Before starting the office, check the conditions of the compressor, close the air reservoir drain and turn On it, observe its operation until its first automatic shutdown.



At the beginning of activities, check the autoclave.



Protect your equipment from direct exposure to sunlight. Direct exposure of the equipment to sunlight may cause premature aging of plastic covers.



Check daily and perform drainage if necessary, from compressor and equipment moisture filters such as pressure regulator for instruments, prophylaxis system filter, compressed air line filter, before using the equipment.



To isolate the equipment from the main power, disconnect the main circuit breaker from the equipment's mains power supply.



This equipment does not have a battery pack.



Do not allow objects, equipment parts or cart castors to rest on the hoses. This may cause damage to the equipment and impair its proper operation.



The mains cable and the ultrasonic scaler transducer are designed for exclusive use on the Olsen's Cart with Compressor. The use of these components in other equipment might compromise their emissions and electromagnetic immunity.







Use only the ultrasonic scaler cable and transducer supplied with the equipment. The use of a cable or transducer other than those specified (see **Chapter 10 - Technical Features**) may result in increased emissions or reduced electromagnetic immunity of the Olsen's Cart with Compressor.





This equipment is not suitable for use in the presence of a flammable anesthetic mixture with air, O₂ or Nitrous Oxide.











Do not use the equipment with water pressure, compressed air or electrical voltage outside the specifications given in **Chapter 8** of this manual. Using the equipment outside the specified conditions may cause loss of functionality. Equipment defects resulting from the equipment usage outside of its specifications will not be covered by warranty.

-  **Only the authorized technician can replace this equipment's mains cable and internal fuses.**
-  **Do not replace the fuse in the electrical panel while it is switched On. There's risk of electric shock. Turn Off the On/Off switch on the electrical panel before replacing the fuse.**
-  **Do not install or use any electrical equipment over or near the Olsen's Cart with Compressor. If necessary, the Cart with Compressor must be checked to see if it is functioning normally in the configuration in which it will be used.**
-  **Do not do cleaning or maintenance of the equipment while it is in use, with the patient or switched on.**
-  **Do not perform the following procedures if it is possible to touch the patient, even if unintentionally, during the procedure:**
 - a) Coupling or removal of the electrical micromotor from its coupling;
 - b) Coupling or removal of the ultrasonic scaler from its coupling;
 - c) Coupling or removal of high-speed optical fiber handpiece from its coupling;
 - d) Fuse replacement.

13.2 - Disposal

-  **Debris, residues and infectious materials resulting from the procedures performed on this equipment must be deposited in biological waste duly identified and in accordance with current legislation.**
-  **For proper disposal of this equipment and its components and accessories, we recommend that it be sent to specialized recycling companies to ensure the best destination of each component without harm to the environment.**
-  **The draining of this equipment should not be disposed of in a common sewage system, complying with the requirements established by the health agencies.**

13.3 - Transport and Storage

-  **It is recommended that the equipment transportation and storage be made in its original packaging.**
-  **Transport carefully protecting equipment from falls and impacts.**
-  **Protect from moisture, rain exposure and direct contact with liquids.**
-  **Keep it sheltered from the sun.**
-  **Do not heap up more than 4 volumes.**
-  **Temperature range for transportation and storage: -10° C to +45° C.**
-  **Moisture limits for transport and storage: 20% to 70%.**
-  **Do not move or store the equipment on uneven surfaces.**

13.4 - Contraindications

This equipment is contraindicated for any use other than that for which it is intended or to be operated by unqualified personnel.

13.4.1 - Contraindications on the Ultrasonic Scaler Use

It's forbidden the scaler use of hemophilic patients.

Patients, dentists or dental assistants with pacemakers are prohibited from using or approaching the scaler during its use.

The scaler uses in cardiac, pregnant or child patients should be performed with precautions.

13.4.2 Curing Light Contraindications

The curing light use in cardiac, pregnant or child patients should be performed with precautions.

14 - Troubleshooting

For solving possible problems in a simple and practical way, just follow the instructions in the following tables:

Item	Problem	Causes	Solutions
1	Equipment does not turn on	1°-The equipment is not connected to the mains electricity	1°-Connect the equipment to the mains electricity
		2°-Electrical circuit breaker is switched off	2°-Switch On the electrical circuit breaker
		3°-There is no power on the mains electricity	3°-Call the power supply company
		4°-The protection fuse is blown	4°-Contact Olsen certified assistance
2	Pneumatic handpiece (micromotor/turbine) doesn't work or is weak	1° - The handpiece ducts are clogged.	1° - Lubricate the handpiece ducts.
		2° - There's looseness on the handpiece coupling.	2° - Attach the handpiece correctly.
		3° - The air valve is not completely open.	3° - Open the air valve.
		4° - There's insufficient air pressure for the equipment.	4° - Open the main air valve.
		5° - The air compressor is not working properly.	5° - Call the air compressor assistance.
		6° - There's a blocking in the pneumatic system.	6° - Contact Olsen certified assistance.
3	Pneumatic handpiece has water leakage on the coupling	1° - There's looseness on the handpiece coupling.	1° - Attach the handpiece correctly.
		2° - The gasket is worn.	2° - Replace the gasket.
		3° - The gasket is not properly sealing the coupling.	3° - Apply original handpiece seal.
		4° - The coupling is worn.	4° - Contact Olsen certified assistance.
4	The pneumatic handpiece doesn't have water on the spray	1° - The coupling spray's adjustment is closed.	1° - Align the coupling's green dots.
		2° - The water tank is empty.	2° - Fill the water tank.
		3° - There's looseness on the handpiece coupling.	3° - Attach the handpiece correctly.
		4° - The air valve is not completely open.	4° - Open the air valve.
		5° - There's insufficient air pressure for the equipment.	5° - Open the main air valve.
		6° - The hydro-pneumatic system is locked.	6° - Contact Olsen certified assistance.
5	The saliva ejector is weak or loses suction during the procedure	1° - The saliva ejector's filter is clogged.	1° - Clean the saliva ejector's filter.
		2° - There's insufficient air pressure for the equipment.	2° - Open the main air valve.
		3° - The equipment's drain hose is obstructed.	3° - Check if the sewer's drain pipes are crushed and release the flow.
		4° - The sewer is clogged.	4° - Check if there's water outflow and clean the sewer if necessary.
		5° - The hydro-pneumatic system is locked.	5° - Contact Olsen certified assistance.
6	The curing light isn't working	1° - There's a problem with power supply.	1° - Check <i>Troubleshooting, item 1.</i>
		2° - Block of 10 consecutive activations.	2° - Wait at least for 20 seconds to activate the curing light again.
		3° - Possible overheating.	3° - Contact Olsen certified assistance.
7	The ultrasonic scaler vibrates little or nothing	1° - There's a problem with power supply.	1° - Check <i>Troubleshooting, item 1.</i>
		2° - The tip is not properly attached to the transducer.	2° - Remove and attach the tip again using the Torque wrench.
		3° - The tip is worn, or the ultrasonic scaler has a defect.	3° - Contact Olsen certified assistance.
8	The ultrasonic scaler is overheating	1° - The vibration control is not adjusted according to tip specification.	1° - Adjust the ultrasonic scaler power control according to the tip specification.
		2° - The tip is not properly attached to the transducer.	2° - Remove and attach the tip again using the Torque wrench.
		3° - The tip is worn, or the ultrasonic scaler has a defect.	3° - Contact Olsen certified assistance.
9	The ultrasonic scaler has little or no water	1° - The water tank is empty.	1° - Fill the water tank.
		2° - The ultrasonic scaler water valve is closed.	2° - Open ultrasonic scaler water valve.
		3° - The tip has a hydro-pneumatic system.	3° - Contact Olsen certified assistance.

10	The turbine's optical fiber light doesn't work	1° - The equipment is not performing the movement.	1° - Check <i>Troubleshooting, item 1.</i>
		2° - The optical fiber's light is switched OFF.	2° - Turn On the optical fiber's light switch.
		3° - The handpiece is not properly attached.	3° - Reattach the handpiece until the joint gasket is tighter.
		4° - There's a pneumatic or electronic problem.	4° - Contact Olsen certified assistance.
11	The electrical micromotor doesn't work or it's malfunctioning	1° - The equipment is not performing the movement.	1° - Connect the equipment to the main electricity.
		2° - Pneumatic handpieces are not working	2° - Check <i>Troubleshooting, item 5.</i>
		3° - The rotation's direction switch is on OFF position.	3° - Set the rotation's direction switch to FWD or REV position.
		4° - The speed control is adjusted to minimum speed.	4° - Increase the micromotor's rotation speed.
		5° - There's a pneumatic or electronic problem.	5° - Contact Olsen certified assistance.

If you are in doubt or find a problem with the equipment that is not mentioned in this chapter, stop using the equipment immediately and contact your authorized service center or contact us by e-mail export3@olsen.odo.br or by calling +55 48 2106 6000.

15 - Preventive Review

In order to extend your equipment's lifespan, Olsen has created the extended warranty system by performing scheduled service maintenance.

During the service maintenance, the technician will evaluate the equipment's general maintenance condition, as well as the monitoring of component wear and if there is a need for lubrication.

The technician may suggest the replacement of the parts with wear and tear and will provide guidance on the daily care necessary for the proper equipment functioning.

The following tables list the items that must be checked by the technician:

DOUBLE PEDAL
Check of all pedal controls.
Check of the progressive pedal's valves.
Check of the pressure regulator for instruments.

WORKING TABLE
Check of the cart castors.
Check of the pneumatic couplings pressure and rings.
Check the valves, blades, and handpieces holders.
Check of the ultrasonic scaler tips wear and tear.
Disassembly and lubrication of the 3-way syringe's buttons.

CURING LIGHT
Check of the intensities and operation modes.
Check for the tips and supporting ring.

Olsen recommends that the preventive maintenance of the items indicated in this chapter be performed every 180 days, to prevent possible failures or loss of equipment performance, even after the expiring of the warranty period.

The performance of preventive or corrective maintenance by an accredited technician does not interfere with the warranty period.



Use only Olsen original parts and accessories. The use of non-original components can compromise the performance of the equipment, increasing its emissions or reducing its electromagnetic immunity.



Do not make adaptations, modifications or changes to the equipment or its components or accessories.

16 - Registro de Revisão

To your control, register technician data and revisions dates here:

REV. 180 DIAS	
Ordem de Serviço Nº	_____
Em	_____/_____/_____
Ass. Técnica	_____
Nome do Técnico	_____

17 - Warranty Terms

The warranty period for this product is 12 months, counted from the equipment installation date, considering the 90 days legal warranty term, provided that the installation is performed within the period of 90 days from the product's Purchase Invoice issue and the fulfilled of other requirements of this certificate.

9 - The maximum term of storage is 3 months from the date of purchase of the product. If the storage period is exceeded, the guarantee is still in progress, even if the product is still stored.

10 - Upholstered parts are guaranteed for 6 months.

11 - Fuses, cables and transformers are not covered under warranty.

12 - The warranty is limited to repair or replacement of defective parts and does not cover defects originated by:

- a) Non-compliance with the instructions for use and maintenance;
- b) Falls, crashes and inadequate storage;
- c) Action of nature agents;
- d) Damage to upholstery, improper use of chemicals, exposure to unsuitable weather conditions, contact with tissues, leather, disposable gloves, paints, pigmented detergents, razors or any sharp instruments;
- e) Damage to painted parts and plastic covers caused by improper use of chemicals or by contact with disposable gloves and sharp or piercing objects;
- f) Connection to wrong voltage power supply.

13 - This warranty will cease when:

- a) In the normal course of its period of warranty;
- b) Make changes in the product not authorized by Olsen;
- c) Adulterations in the purchase, installation or services document;
- d) Installation or technical assistance made by a person not authorized by Olsen;
- e) Failure to install the equipment for more than 90 days, counted from the purchasing date contained in the invoice;
- f) By using non-genuine spare parts.

14 - The parts repairing or replacement during the warranty period will not extend the original expiry date.

15 - The expenses originated from the unit installation, scheduled preventive maintenance, travel, and hotel of the service staff involved in the calls for service for installation or units repair will run under the unit's owner responsibility and in accordance with the distributor's norms.

16 - The purchaser, after verifying the services performed in the installation and revision of the equipment, must date and sign the service order provided by the technician and keep along with his invoice of purchase of the equipment, failing which the warranty extension product when necessary.

17 - All service requests for warranty equipment must be made with the serial number of the equipment to be serviced and a copy of the purchase or installation document. If this information is not communicated, the service request will be made as not covered by the warranty.

18 - Message from the President

Olsen and its clients:
A successful relationship.

I have linked my name to the factory and to the dental and medical equipment that are currently produced and trade in more than 100 countries having in mind the responsibilities and long-term response to this initiative.

Our products are modern, innovative, durable and of low maintenance cost. These characteristics have been achieved thanks to our competent and dedicated team, which make me very proud for many reasons, as they are always giving the best of their creative capacity to our clients.

Our company will always be open to all those who prefer Olsen products, for any necessary information and technical assistance, but especially for comments regarding the relationship with customers. We expect this connection always brings you satisfaction, resulting in more and more benefits to all of us

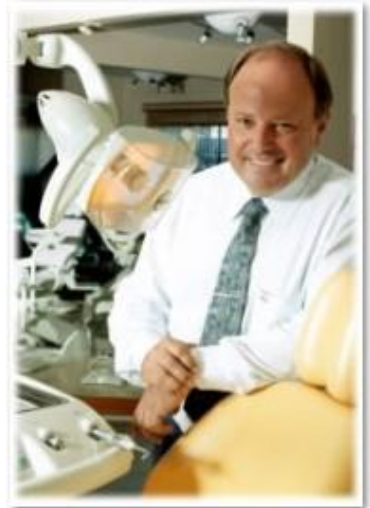

Cesar Olsen

+55 48 2106 6000
export3@olsen.odo.br

///Olsen

Equipment made to last

www.olsen.odo.br

Registration at Ministry of Health 1028130009

Technician in Charge Eng. Cleber da Costa - CREA SC: S1 116283-5

Cod 5409212 - Rev 04 - 29/09/2021

OLSEN INDÚSTRIA E COMÉRCIO S.A.
Av. Ivo Lucchi, 68, Distrito Industrial, Jd. Eldorado Palhoça/SC - Brazil
CEP 88133-510 - Tel: +55 (48) 2106-6000
www.olsen.odo.br
www.olsen.vet.br