

Olsen VET

COMPACT PIEZO



Olsen

Manufacturing high quality
equipments for 40 years



olsen.vet.br

 [olsen.vet](https://www.instagram.com/olsen.vet)



Attention: Read this manual carefully before using the Olsen equipment.

Index

1 - Introduction	4
2 - Package Contents	4
3 - Parts Identification	4
3.1 - Applied Parts	4
3.2 - Accessories and Detachable Parts	4
4 - Equipment Description and Operating	5
4.1 - Before Turning On The Equipment	5
4.2 - Turning On The Equipment	5
4.3 - Contra-Angle and Straight Handpiece	6
4.3.1 - Installing the Drill	6
4.3.2 -Using the Contra-Angle or the Straight Handpiece	7
4.4 - Scaler with LED	7
4.4.1 - Scaler Use Precautions	7
4.5 - 3-Way Syringe	8
5 - Technical Specifications For Operation	8
5.1 - Pre-operation	8
5.2 - Equipment Positioning	8
5.3 - Water for the Tank	8
5.4 - Electrical Installation	8
6 - Receiving	9
7 - Olsen Accredited Technical Assistance Network	9
8 - Cleaning, Lubrication and Disinfection	9
8.1 - Plastic Parts	9
8.2 - Painted Parts	10
8.3 - Scaler	10
8.4 - Contra-Angle Cleaning	10
8.5 - Autoclave Sterilization	11
8.6 - Lubrication	11
8.7 - Daily Procedure for Finalizing Operations	12
9 - Technical Features	12
10 - Symbology	13
11 - Dimensional	14
12 - Important Notes	14
12.1 - General Cares - Compulsory Reading	14
12.2 - Disposal	15

12.3 - Transportation and Storage	15
12.4 - Contraindications	16
12.5 - Contraindications to Scaler Use	16
13 - Troubleshooting	17
14 - Warranty Terms.....	18
15 - Message from the President	19

1 - Introduction

Congratulations on the great choice!

You have acquired an equipment developed for the clinical and outpatient environment, aimed at meeting the needs of health professionals in the veterinary area, especially the dentistry area.

This manual is provided with your equipment and presents all the necessary information so that you can get the most out of your equipment, so read it carefully before using it.

2 - Package Contents

Standard items:

- 1 Main Unit
- 1 Scaler with LED
- 1 C1-2 Contra-Angle Handpiece
- 1 3-Way Syringe
- 3 Scaler Tips
- 1 Endo Switch
- 1 Torque Wrench
- 1 Olsen Turbo Oil Lubricant
- 1 Compact Piezo User's Manual



Optional Items

- C7-2 Contra-Angle Handpiece
- S-2A Straight Handpiece

3 - Parts Identification

- A - Progressive Foot Pedal
- B - Electric Micromotor
- C - Electrical Micromotor Rotation Direction Control
- D - Electrical Micromotor Speed Control
- E - Water Tank
- F - Micromotor/Scaler Selector
- G - Scaler Function/Speed Control
- H - Scaler with LED
- I - 3-Way Syringe
- J - Water Flux Control



3.1 - Applied Parts

The following items are considered as applicable parts to the patient:

Standard Items:

- Scaler with LED;
- 3-Way Syringe;
- C1-2 Contra-Angle Handpiece.

Optional Items

- C7-2 Contra-Angle Handpiece
- S-2A Straight Handpiece

3.2 - Accessories and Detachable Parts

Detachable Parts:

- Scaler tips;
- Scaler transducer;
- Syringe Tip;
- C1-2 Contra-Angle Handpiece;
- Water Tank;
- Progressive Foot Pedal.

Accessories:

- C7-2 Contra-Angle Handpiece
- S-2A Straight Handpiece

4 - Equipment Description and Operating

The Compact Piezo is an equipment developed for the clinical and outpatient environment, focused on the specialty of veterinary dentistry, with the objective of facilitating the performance of procedures by the professional.

Its structure is manufactured in high strength ABS with acrylic coating that does not require painting, enabling polishing for recovery in case of wear or scratches.

It is equipped with instruments for veterinary dental use driven through pedal and its internal structure is made of resistant material.

Before you start using your equipment make sure that it is on a flat, solid surface, and is connected to the energized power supply.

4.1 – Before Turning On The Equipment

- 1° - Check if the power supply is in accordance with instructions of section 5 (*Technical Specifications for Operation*) of this manual;
- 2° - Check if the equipment voltage selector switch (1), on the side of the fuse holder (2), is in accordance with the power supply voltage supplied to the equipment (section 5.4 - *Electrical Instalation*);
- 3° - Put the equipment on a flat and solid surface;
- 4° - Check if the water tank (3) is full. If necessary, fill it with mineral or filtered water and attached it again to the equipment, checking if it is properly attached and without leaks.



4.2 – Turning On The Equipment

- 1° - Connect the equipment to the power supply;
- 2° - Turn On the On/Off Switch (4) on the back side of the equipment, the On/Off switch (4) will light up, indicating that the equipment is energized;
- 3° - Before first treatment, check the operation of the instruments.



To avoid accidents, the equipment must be operated only by professionals.



After each treatment turn off the water and power switches (section 3 - Parts Identification).



Do not use the equipment without water in the tank. Observe the minimum water level of 1 cm in height, replacing its contents when necessary.

4.3 – Contra-Angle and Straight Handpiece

The Contra-Angle C1-2 (2) goes connected to Olsen electric micromotor (1) that has speed and direction of rotation control. As an optional, you can also use the C7-2 Contra-Angle (4) or S-2A Straight Handpiece (3).

Micromotor technical features:

- **Rotation speed:** from 0 to 35,000 rpm
- **Torque:** 270g-cm
- **Power:** 24 VCC
- **Max. Power:** 60 W



C1-2 Contra-Angle technical features:

- **Rotation speed:** 40,000 rpm
- **Transmission ratio:** 1:1
- **Mandrel type:** wrench
- **Drill:** Ø2.35 - 0.016 mm
- **Spray type:** external



Technical features S-2A Straight Handpiece (optional):

- **Velocidade de rotação:** 40.000 rpm
- **Transmission ratio:** 1:1
- **Mandrel type:** wrench
- **Drill:** Ø2.35 - 0.016 mm
- **Spray type:** external



C7-2 Contra-Angle technical features (Optional):

- **Rotation speed:** 200.000 rpm
- **Transmission ratio:** 1:5
- **Mandrel type:** push button
- **Drill:** Ø2,35 - 0,016 mm
- **Spray type:** internal



Before starting operation connect (5) the contra-angle (2/4) or the straight handpiece (3) to the electric micromotor (1). Tighten the coupling so that the micromotor (1) remains firm and leak-free during use.

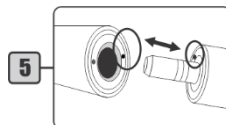

4.3.1 – Installing the Drill

- 1º - Insert the drill into the head of the contra-angle (2) or straight handpiece (3) and rotate it gently until it fits into the mechanism;
- 2º - Move the drill lever (6) to the right and insert the drill and move the lever to the center of the contra-angle.
For the straight handpiece (3) turn the locking ring (7) to the right until you hear a click and insert the drill until it touches the inner base of the instrument head;
- 3º - Check if the drill is safe by pulling it and pushing it gently;
- 4º - To remove the drill, move the drill bag lever (6) or rotate the locking ring (7), and then pull it.

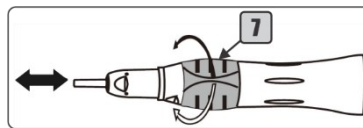
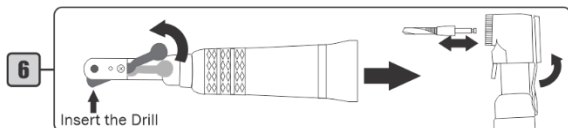

4.3.2 - Using the Contra-Angle or the Straight Handpiece

To turn on rotation: Select the contra-angle or straight handpiece on the instrument selector button (7) and press the progressive foot pedal (4).

To adjust the speed: turn the control knob (5) until you reach the desired speed.

To change the direction of rotation: use the rotation selector (6).

- **FWD:** clockwise;
- **OFF:** off;
- **REV:** counterclockwise.

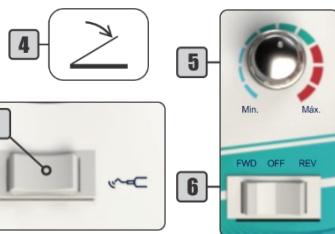

 **To change the direction of rotation, wait for micromotor to stop turning completely.**

4.4 – Scaler with LED

The Scaler has an ultrasonic electronic generation board that, through piezoelectric system, provides the vibration of the tip, giving high frequency condition. When activated the Scaler starts the vibration of the tip, activates the LED and opens the water passage for cooling. Vibration power and cooling water flow control can be adjusted via individual controls.

This instrument was developed for use in dental applications, such as scarification, root smoothing, canal treatment, periodontal and cavitory preparation.

Technical features:

- **Frequency:** 28 kHz \pm 3 kHz;
- **Power supply:** 24 VCA;
- **Output force (half-displacement):** <2N;
- **Power rating:** from 3 to 20 W;
- **Operation mode:** Continuous;
- **Vibration displacement of the tip:** \leq 100 μ m;

For scaler operation is necessary to connect the transducer (2) in the terminal (4) and install the Scaler tip on the transducer.

To attach the transducer to the terminal: align the dots (3) of the two parts and carefully fit them.

For installation of scaler tips: attach the tip to the transducer (2) by threading it carefully, then place the torque wrench (6) embedded in the tip and then rotate it clockwise until firm. To remove the tip, turn it counterclockwise with the torque wrench (6). After installing the tip, check for leakage between the transducer (2) and the terminal (4).

To activate the scaler: select the scaler on the instrument selector button (5) and press on the progressive foot pedal (1).

To adjust the vibration power: turn the control knob (7) until it reaches the desired power.

To switch functions: on the control button (7) select between the function "GP" (General and Perio) or "E" (Endo). Pull the button gently in the opposite direction to the table for function "E" (Endo).

To adjust water: use the water flow control button (8).

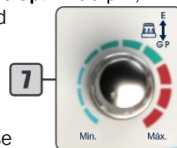
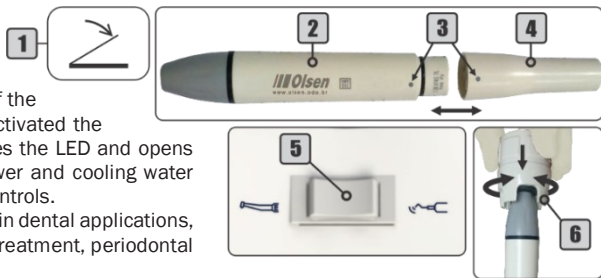

 **It is not possible to switch PG/E functions during scaler operation (pedal driven).**

 **Apply only the power parameters and function type specified for each tip. Do not exceed the specified parameters. This may compromise the performance of the equipment and cause overheating or locking.**

4.4.1 – Scaler Use Precautions

- Check out the vibration outside the patient's oral cavity before use. If any abnormality is found, discontinue use immediately and contact a Certified Olsen Assistance;
- Always use gloves when handling the ultrasonic scaler, tips, torque wrench and its removable covers;
- Use only the torque wrench to fix and remove tips. If the tip is not fixed properly, it will present vibration loss;
- This ultrasonic scaler has been developed for professional dental use only and should not be used for any other purpose;
- The tip wears out with use, this can cause reduction of power. If this occurs, replace the tip;

- Do not sharpen or bend the tip. Tips can be damaged and do not generate enough vibration during scarification;
- While in use, the ultrasonic scaler system may affect computers and LAN cables. During an operation next to radio device, interference may be heard;
- Use only autoclave proper for dental use to sterilize tips, torque wrenches, transducer and LED;
- Before installing any tip on the ultrasonic scaler, check its maximum intensity power. Using power above recommended will cause tip damage and ultrasonic scaler;
- Keep it away from patients with cardiac pacemakers or anesthetized;
- During the ultrasonic scaler use, the tip temperature may rise if the spray is not used. Always use enough spray water for the cooling of the handpiece and the teeth;
- Use the device only on the teeth. Contact with skin, gums and mucous membranes may cause injury;
- Keep the ultrasonic scaler away from explosives and flammable materials;
- Do not submit the handpiece to any strong impact, or drop it;
- Do not exceed the recommended intensity for the tip this may damage the tooth and tips;
- Do not use it on metal, or ceramic, porcelain or resin prostheses;
- Do not touch and do not wet the back of the transducer, where there are electrical connections to the power cord. This can result in electric shock;
- Do not force the ultrasonic scaler cable when remove it. This may cause disconnection.

4.5 – 3-Way Syringe

Before beginning the use of the 3-way syringe (5), connect the syringe tip (3) by pressing the locking ring (4) into the correct fit.

To emit air jet: Press the Air button (1).

To emit water: Press the Water button (2).

To emit spray jet: Press simultaneously the Water and Air buttons.

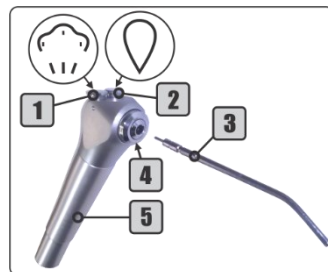

5 – Technical Specifications For Operation

5.1 - Pre-operation

Before using the equipment check the available power supply points, predicting for possible positioning for use of the equipment and other utensils arranged in the environment.

5.2 - Equipment Positioning

Define a flat, stable, regular, and dry location for put the equipment in a way that facilitates its operation and ensures access to all your controls and connections.

5.3 – Water for the Tank

Use drinking, filtered or boiled water to supply the tank. This water will be used to supply the 3-way syringe, scaler and micromotor.

5.4 – Electrical Installation

The Equipment can operate at frequencies of 50 or 60 Hz and offers voltage selector for 127/220 Volts, also with On/Off switch and protection fuses.

Olsen recommends that the electrical grid where the equipment will be used has the following specifications:

- Has single-phase connection;
- Grounding;
- Voltage 127/220 Volts;
- Network cable gauge of at least 1.5mm²;
- Current 10 A.

Note: If the power grid varies in voltage, include a power stabilizer.

 Before turning on the equipment make sure that the electrical voltage of the equipment is the same voltage as the power grid. There is a risk of damage to the equipment!

 This equipment should only be connected to a power source with protective grounding. There is an electric shock risk.

 Do not place the equipment on a place that makes it difficult to disconnect it from the power grid.

6 - Receiving

It consists of receiving the equipment and verifying its integrity and operation.

Olsen recommends that the equipment owner track your receipt and checklist:

- 1 - Did the equipment arrive on request and were delivered in perfect condition?
- 2 - Is the electrical network correct, with proper wiring and grounding for the equipment according to *section 5.4 (Electrical Installation)* of this manual?
- 3 - Is there a circuit breaker suitable for protection of the equipment, according to *section 5.4 (Electrical Installation)* of this manual?
- 4 - If the voltage has voltage variation, has a stabilizer been installed for the equipment, as indicated in *section 5.4 (Electrical Stalation)* of this manual?
- 5 - Are all the commands and instruments on the equipment working properly?

 **At the end of the receipt check the water connection, the connections of the instruments and if there are leaks.**

7 - Olsen Accredited Technical Assistance Network

To access the Olsen certified technical assistance network for installation and maintenance or contact us by e-mail export3@olsen.odo.br or if you prefer +55 48 2106 6000.

 **Installation should be made only by an authorized technician. Installation performed by an unauthorized person will result in loss of warranty.**

 **Use only original Olsen parts and accessories. The use of non-original components can compromise the performance of the equipment, increasing its emissions or reducing its electromagnetic immunity.**

 **Do not make adaptations, modifications or changes to the equipment or its components or accessories.**

8 - Cleaning, Lubrication and Disinfection

 **The whole sanitize process must be done with the use of gloves suitable for cleaning and protection, in addition to a mask and protective glasses, according to biosafety standards.**

 **All equipment items mentioned in this chapter must be sanitized and sterilized (when appropriate) prior to use.**

 **Before starting to clean the equipment, turn off the power supply and keep the ambience clean.**

 **This unit is not equipped with a water sterilization system. In order to ensure that the sterilization of the unit does not affect the quality of the water, the handpieces, the tip of the syringe and its cable, they should be sterilized after each use.**

8.1 - Plastic Parts

Plastic parts should be cleaned with damp cloth containing only soap or neutral detergent. Olsen advises against the use of any chemical for cleaning these parts, but in the case of a disinfection product, it is important to verify that it has compatibility and characteristics suitable for use on this material.

 **Never use hypochlorite or alcohol-based products.**

8.2 - Painted Parts

It must be cleaned with a slightly damp cloth containing only soap or mild detergent.



Never use hypochlorite or alcohol-based products.

8.3 - Scaler

The transducer (5), the LED (3), the tips, Torque and Endo wrenches must be autoclaved for sterilization, as instructed in section 8.5 (Sterilization by Autoclave).

Prior to the transducer sterilization, remove the tip (if it is attached), the LED removable cover (1), the light driver (2) and the finishing ring (3). These items should be sterilized with 70% alcohol.

For proper functioning of the ultrasonic scaler, the LED must be correctly inserted in the transducer matching the LED's positive pole (6) with the transducer's positive pole.

Use only autoclave for sterilization of tips, Torque and Endo wrenches, transducer, and LED.

The following methods of sterilization are forbidden:

- Put in boiling water;
- Heat in stove, oven or microwave;
- Soak in disinfectants such as iodine, alcohol or glutaraldehyde.

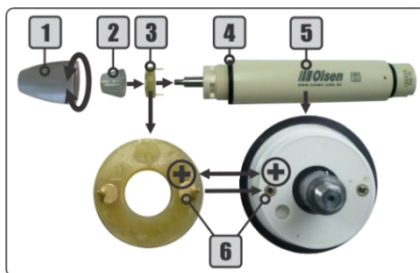

8.4 - Contra-Angle Cleaning

1° - Remove the drill from the handpiece;

2° - Remove debris in and around the outlet holes with a soft bristle brush

3° - Fill half a glass with clean water. Activate the handpiece for about 15 seconds and immerse 20 mm from the handpiece head in water;

4° - Lubricate before taking the piece to the autoclave (section 8.6 - Lubrication).

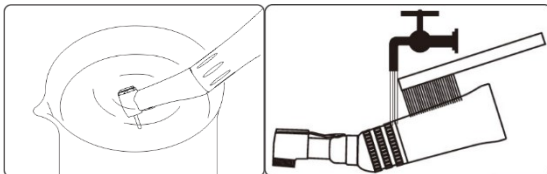

Immediately after each use, the handpiece should be cleaned and lubricated, and any liquid or fragment that may have penetrated (e.g. blood, saliva) should be washed to avoid residues on the internal components.



When cleaning dirt from the outer surface of the handpiece, make sure that no water comes into the back of the handpiece.



If you are unable to remove all dirt from the holes, use a brush.



After cleaning store the device in a safe place in order to avoid damage and environmental pollution.



Do not use a steel brush when cleaning the instrument.



Do not use detergent or hot water (> 40° C), as this will cause the residue to be fixed, affecting the cleaning effect.



Do not soak or clean the handpiece in potentially oxidisable solution (strong/superacid acid solution) or sterile solution.



If the internal liquid of the handpiece is not cleaned properly and the drying is incomplete, the internal parts may become corroded.

8.5 - Autoclave Sterilization

Prior to autoclaving, clean the items, removing any organic residue, both from the surface and internal ducts (if any). Then carefully dry each item, including the internal ducts, if possible, with compressed air. Individually pack each item, with its own sterilized packaging for the autoclaving process.

For steam autoclaving, the following values may be used (sterilization in accordance with ISO 17665):

- a) 130° C, 2 bars, 15 min; b) 120° C, 1 bar, 30 min; c) 134° C, 2,2 bars, 4 min.

The following equipment items are autoclavable:

- Syringe tip;
- Torque and Endo scaler wrench;
- Scaler transducer;
- Scaler tips.

To sterilize the ultrasonic scaler tips, set the autoclave to 132° C for 3 to 6 minutes at a pressure of 30 PSI (2 bar) or as indicated on ISO 17665 standard.

Regarding the resistance to the autoclaving process, the following items support:

- Up to 1000 cycles: tips, scaler wrench and syringe tip;
- Up to 600 cycles: Scaler transducer;



Do not use any type of oil on the items to perform autoclaving.



If damage is found during repetitive processing, stop using immediately.



Do not autoclave handpiece containing residual chemical. Risk of damage to the handpiece!



Do not touch the handpiece right after the autoclave, device will be extremely hot.

8.6 - Lubrication



Always lubricate the instrument before autoclave and immediately after each use.



Use Turbo Oil Olsen for daily instrument lubrication.

1° - Unplug the handpiece from the motor;

2° - Remove the bit, and keep the drill lever open (right side);

3° - To perform lubrication, shake the lubricant can (3), identify the air duct of the handpiece (1) then connect the Nozzle E (2), supplied with the contra-angle, into the nozzle of the lubricant (3) then install it on the back of the transmission of the contra-angle (4). Apply 2 to 3 seconds of jet, until the lubricant is outleted through the instrument head.

4° - After lubrication, keep the contra-angle standing so that excess lubricant comes out.

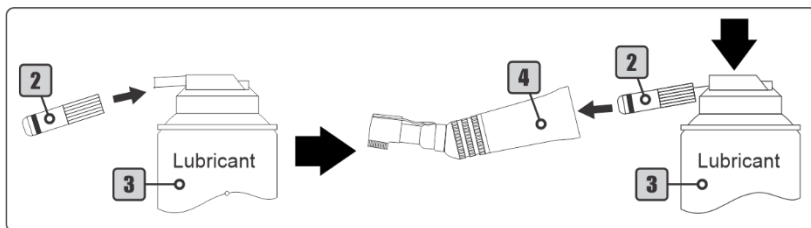

When lubricating the instrument, hold it firmly to prevent it from escaping from your hands and falling due to the strength of the lubricant jet.



Stop applying the spray when the lubricant appears on the opposite side of the part.



Keep the can standing during spray application.

8.7 - Daily Procedure for Finalizing Operations

As you finish the working day, observe the following instructions:

- Adjust the maximum water flow in the equipment and activate each instrument for 30 seconds for cleaning the internal ducts;
- Provide the cleaning of the equipment, performing the cleaning of its hoses, fairings and metal parts, as indicated in *chapter 8 (Cleaning, Lubrication and Disinfection)*;
- Remove the instruments used during the day: tip of the syringe, the transducer and Scaler tips and provide the sterilization of each one, as indicated in *chapter 8 (Cleaning, Lubrication and Disinfection)*;
- Remove the water from the tank;
- Turn off the On/Off switch on the equipment;

9 - Technical Features

Power supply: 127/220V;



The voltage must be selected at the time of installation according to the voltage of the establishment.

Note: All equipment is factory set to 220V.

Number of phases: single phase.

Frequency: 50/60 Hz.

Power rating: 36 VA.

Protective fuses:

- **For 127V:** F 1,0 A H (5 x 20 mm);
- **For 220V:** F 0,5 A H (5 x 20 mm).



If the equipment voltage needs to be changed to 127 V, replace the fuse that came with the equipment (1 A) as indicated above.

Environment conditions for operation:

- **Temperature:** andntre 15° and 28°C;
- **Pressure:** 75 kPa to 106 kPa;
- **Moisture relative:** 30% to 70% without condensation.

Weight:

- **Net:** 4,450 kg;
- **Gross:** 5,100 kg

Water tank capacity: 1 L;

10 - Symbology

	Multifunction Syringe (Air-Water)		Dental Air Motor		Turbine
	Turbina Pneumática com Iluminação		Micromotor Elétrico		Ultrassom
	Turbine with Illumination		Saliva Ejector		Suction Handpiece
	Spray-cooling		Variability, for Rotating Movement		Hand Control Valve
	Lighting		Progressive Pedal		Manufacturer
	"OFF" (Power)		"ON" (Power)		General Warning Sign
	Non Sterile		Caution		General Mandatory Action Sign
	Warning, Electricity		Level		Refer to the Instruction Manual
	Operating Instructions		General Prohibition Sign		Type BF Applied Part
	Stepping Prohibited		Type B Applied Part		Aterramento de Proteção
	Esterilizável até a Temperatura Especificada		Serial Number		Humidity Limitation
	Earth (Ground)		Keep Away from Heat		Keep Dry
	Fragile, Handle with Care		Temperature Limitation		Alternating Current
	Heaping Up		This Side Up		

EC REP	Authorized Representative in the European Community
---------------	---

11 - Dimensional

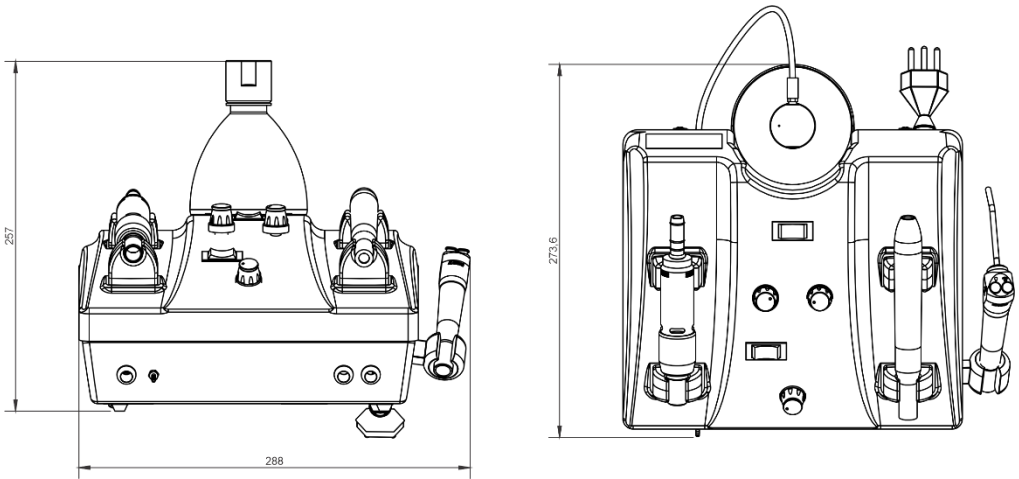

12 - Important Notes

The reproduction and distribution of these instructions can only be made with prior permission from Olsen Indústria e Comércio S.A.

The technical features of the products described in this manual correspond to the time of its publication. Future technical improvements do not result in any right to update existing products.

The images presented in this manual are illustrative.

This equipment is designed to be free from interference from magnetic fields, external electrical influences, electrostatic discharges, pressure or pressure variation, provided that the equipment is transported, installed, operated and sanitized in accordance with the instructions for use contained in this manual.

Hydropneumatics diagrams, electrical diagrams, installation instructions, components grid or any other technical information necessary to installation and maintenance of Olsen Vet Kart Premium will be dispensible by request, by our e-mail: export3@olsen.odo.br or by or telephone: +55 48 2106-6000.

12.1 - General Cares - Compulsory Reading



Follow the instructions in Section 5 of this manual (Technical Specifications for Operation) for better suitability of the environment where the equipment will be used.



Correctly follow the operating instructions in accordance with Section 4 (Equipment Description and Operation) of this manual. Incorrect use may cause damage to equipment that will not be covered by the warranty.



Clean the equipment as instructed in Section 8 (Cleaning, Lubrication and Disinfection) of this manual.



Protect your equipment from direct exposure to sunlight. Direct exposure of the equipment to sunlight may cause premature aging of plastic covers.



To isolate the equipment from the main power, disconnect the main circuit breaker from the equipment's mains power supply.



Ensure that during the procedures all equipment and accessories necessary are within the operator's reach.

 Do not allow objects, equipment parts or cart castors to rest on the hoses. This may cause damage to the equipment and impair its proper operation.

 The scaler transducer connection cable is designed for exclusive use of compact piezo. The use of this component in other equipment may compromise electromagnetic emissions and immunity.

 Use only the ultrasonic scaler cable and transducer supplied with the equipment. The use of a cable or transducer other than those specified (see *Chapter 9 - Technical Features*) may result in increased emissions or reduced electromagnetic immunity of this equipment.

 Do not let the instruments fall to the ground, it may cause damage.

 Keep the power cable out of the patient's reach during the procedure.

 This equipment is not suitable for use in the presence of a flammable anesthetic mixture with air, O₂ or Nitrous Oxide.

 This equipment should only be operated by a veterinarian for veterinary dental examination and treatment.

 Do not disassemble the equipment. Risk of electric shock! Only the Olsen accredited technician is authorized to perform this procedure.

 Do not use or store the equipment in environments other than those specified in this manual, as well as those that are not firm and flat.

 Do not operate, service or clean the equipment while it is in the following situations:

- In contact with the patient;
- Damaged power cord;
- Equipment is not functioning normally;
- Loud noise, overheating of outlet air or bad smell during operation.

12.2 - Disposal

 Debris, residues, and infectious materials resulting from the procedures performed on this equipment must be deposited in biological waste duly identified and in accordance with current legislation.

 For proper disposal of this equipment and its components and accessories, we recommend that it be sent to specialized recycling companies to ensure the best destination of each component without harm to the environment.

12.3 - Transportation and Storage

 It is recommended that the equipment transportation and storage be made in its original packaging.

 Transport carefully protecting equipment from falls and impacts.

 Protect from moisture, rain exposure and direct contact with liquids.

 Keep it sheltered from the sun.

 Do not heap up more than 5 volumes.

 Temperature range for transportation and storage: -15° à + 60° C.

 Moisture limits for transport and storage: 20% a 70%.

 Atmospheric pressure limits for transport and storage: 50 kPa a 106 kPa.



Do not move or store the equipment on uneven surfaces.



If this equipment is not used for a long time, be sure to turn it on once a month, keeping your operation for at least 5 minutes with maximum water flow.

12.4 - Contraindications



This equipment is contraindicated for any use other than that for which it is intended, or to be operated by a person not authorized.

12.5 - Contraindications to Scaler Use



The use of Scaler in hemophilic patients is prohibited.



Patients, veterinarians, or dental procedure assistants with pacemakers are prohibited from using or approaching scaler during use.



The use of Scaler in cardiac patients, pregnant patients or puppies should be performed with precautions.

13 - Troubleshooting

For solving possible problems in a simple and practical way, just follow the instructions in the following tables:

Item	Problems	Causes	Solutions
1	When you turn the on/off switch on the LED does not light up and the instruments do not work	1° - Equipment is not connected to power grid	1° - Connect the equipment to the power grid
		2° - Power breaker is off	2° - Connect the power supply circuit breaker
		3° - Lack of electricity	3° - Contact the electric power company
		4° - If the above solution does not resolve	4° - Contact Olsen authorized assistance
2	On/Off switch on, but instruments do not work	1° - Protective fuses are blown	1° - Change the fuses
		2° - If the above solution does not resolve	2° - Contact Olsen authorized assistance
3	The equipment makes noise even without being in operation	1° - Water tank is empty	1° - Turn off the equipment, fill the water tank and turn the equipment back on
		2° - If the problem persists	2° - Contact Olsen authorized assistance
4	Water leakage in couplings	1° - Slack in instrument coupling	1° - Properly couple the instrument
		2° - Coupling wear	2° - Contact Olsen authorized assistance
5	Micromotor does not work or is weak	1° - Slack in instrument coupling	1° - Properly couple the instrument
		2° - Electronic problem	2° - Contact Olsen authorized assistance
6	The scaler tip does not vibrate and there is no water flow when triggering the scaler	1° - Equipment is not connected to the power grid	1° - Make sure the equipment is connected to the mains
		2° - Badly coupled tip to transducer	2° - Instale a ponta corretamente com a chave adequada
		3° - There is moisture between the transducer and the coupling	3° - Seque as duas partes com ar quente
		4° - Tip is weary or defect in scaler	4° - Contact Olsen authorized assistance
		5° - Electronic problem	5° - Contact Olsen authorized assistance
7	The Scaler tip does not vibrate but there is water flow when you press the pedal	1° - Badly coupled tip to transducer	1° - Install the tip correctly with the proper key
		2° - Poor contact between transducer and coupling	2° - Properly couple the transducer
		3° - Defect in cable or transducer	3° - Contact Olsen authorized assistance
8	Instruments work, however, there is no water flow when triggering the pedal	1° - Water adjustment flow is at a minimum	1° - Open the water register to the desired flow
		2° - The internal duct of the instrument is obstructed	2° - Contact Olsen authorized assistance
		3° - Damaged electropneumatic system	3° - Contact Olsen authorized assistance
9	Water continues to flow after turning off the pedal	1° - Electropneumatic system or damaged seals	1° - Contact Olsen authorized assistance
10	Transducer is heating up	1° - Power incompatible with the tip used	1° - Adjust power as the tip in use
		2° - Badly coupled tip to transducer	2° - Install the tip correctly with the proper key
		3° - Tip with wear or defect in Scaler	3° - Contact Olsen authorized assistance
11	Scaler without water or low water	1° - The water tank is empty	1° - Adicione água filtrada ao reservatório de água limpa
		2° - Scaler water record is closed	2° - Open ultrasound waterlog
		3° - Clogging in the transducer	3° - Contact Olsen authorized assistance

If you are in doubt or find a problem with the equipment that is not mentioned in this chapter, stop using the equipment immediately and contact your authorized service center or contact us by e-mail export3@olsen.odo.br or by calling +55 48 2106 6000.

14 - Warranty Terms

The warranty period is 12 months, counted from the date of the invoice, subject to the other terms of this certificate.

- 1** - LED's, fuses, cables, and transformers are not covered by the warranty.
- 2** - The warranty is limited to repair or replacement of defective parts or instruments, not including repair of defects originating from:
 - Failure to comply with instructions for use and maintenance;
 - Falls, shocks and inadequate storage;
 - Action of agents of nature;
 - Damage to painted parts and plastic parts (fairings) caused by misuse of chemicals or contact with disposable gloves and sharp or piercing objects;
 - Connection to the mains with incorrect voltage.
- 3** - This warranty will cease:
 - In the normal course of its shelf life;
 - Due to product changes not authorized by Olsen;
 - Alterations in the purchase document, installation or services;
 - By use of non-original Olsen parts or accessories.
- 4** - Repair or replacement of parts and instruments during the warranty period shall not extend the original period of validity of the warranty period.
- 5** - All requests for technical assistance for warranty equipment must be made stating the serial number of the equipment to be answered and a copy of the purchase or installation document. If this information is not communicated, the request for technical assistance will be made as not covered by the warranty.

15 - Message from the President

Olsen and its clients:
A successful relationship.

I have linked my name to the factory and to the dental and medical equipment that are currently produced and trade in more than 100 countries having in mind the responsibilities and long-term response to this initiative.

Our products are modern, innovative, durable and of low maintenance cost. These characteristics have been achieved thanks to our competent and dedicated team, which make me very proud for many reasons, as they are always giving the best of their creative capacity to our clients.

Our company will always be open to all those who prefer Olsen products, for any necessary information and technical assistance, but especially for comments regarding the relationship with customers. We expect this connection always brings you satisfaction, resulting in more and more benefits to all of us.

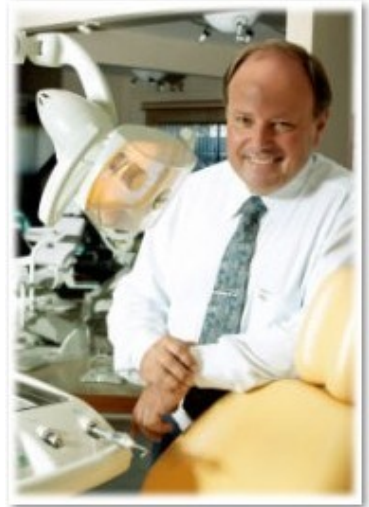

Cesar Olsen



Equipment made to last

www.olsen.odo.br

Cod 5409253 - Rev 03.0.1 - 09/09/2024

OLSEN INDÚSTRIA E COMÉRCIO S.A.

Av. Ivo Lucchi, 68, Distrito Industrial, Jd. Eldorado Palhoça/SC - Brazil

CEP 88133-510 - Tel: +55 (48) 2106-6000

www.olsen.odo.br

www.olsen.vet.br