

# Instructions for Use

# INFINITY



**///Olsen**

[This page has been intentionally left blank]

## Important

The information contained in this document is for an Olsen product equipped with all available instruments and optional items.

Your Olsen equipment may not include all of the features listed here. The information contained in this document is intended as a guide to the use of each feature, and makes no guarantee as to its existence, technical characteristics in your equipment. The illustrations, technical information, and specifications in this publication were current at the time of printing. Olsen Indústria e Comércio S/A reserves the right at any time to revise, modify, discontinue or change any model of its products without notice. Such actions shall not create any obligation or liability for Olsen or the seller in relation to the customer. The total or partial reproduction of this publication, or of its illustrations, or translations, recordings, or photocopies thereof, by mechanical or electronic means, without the prior permission of Olsen Indústria e Comércio S/A, is prohibited.

All rights reserved.

Olsen Indústria e Comércio S/A

## Introduction

### Dear Customer

Congratulations on the great choice!

You have acquired an equipment of high technology and durability, developed and produced following the highest national and international quality standards to provide an excellent experience to the professional and to the patient.

So that you can use the equipment with safety, high performance, and avoid unforeseen events, we recommend that you read this manual carefully, familiarizing yourself with the functions and commands, and following the instructions, recommendations, warnings, and cautions contained in the document. This way, your experience will be even more pleasant and the equipment will perform at its highest performance, ensuring your safety and that of your patient.

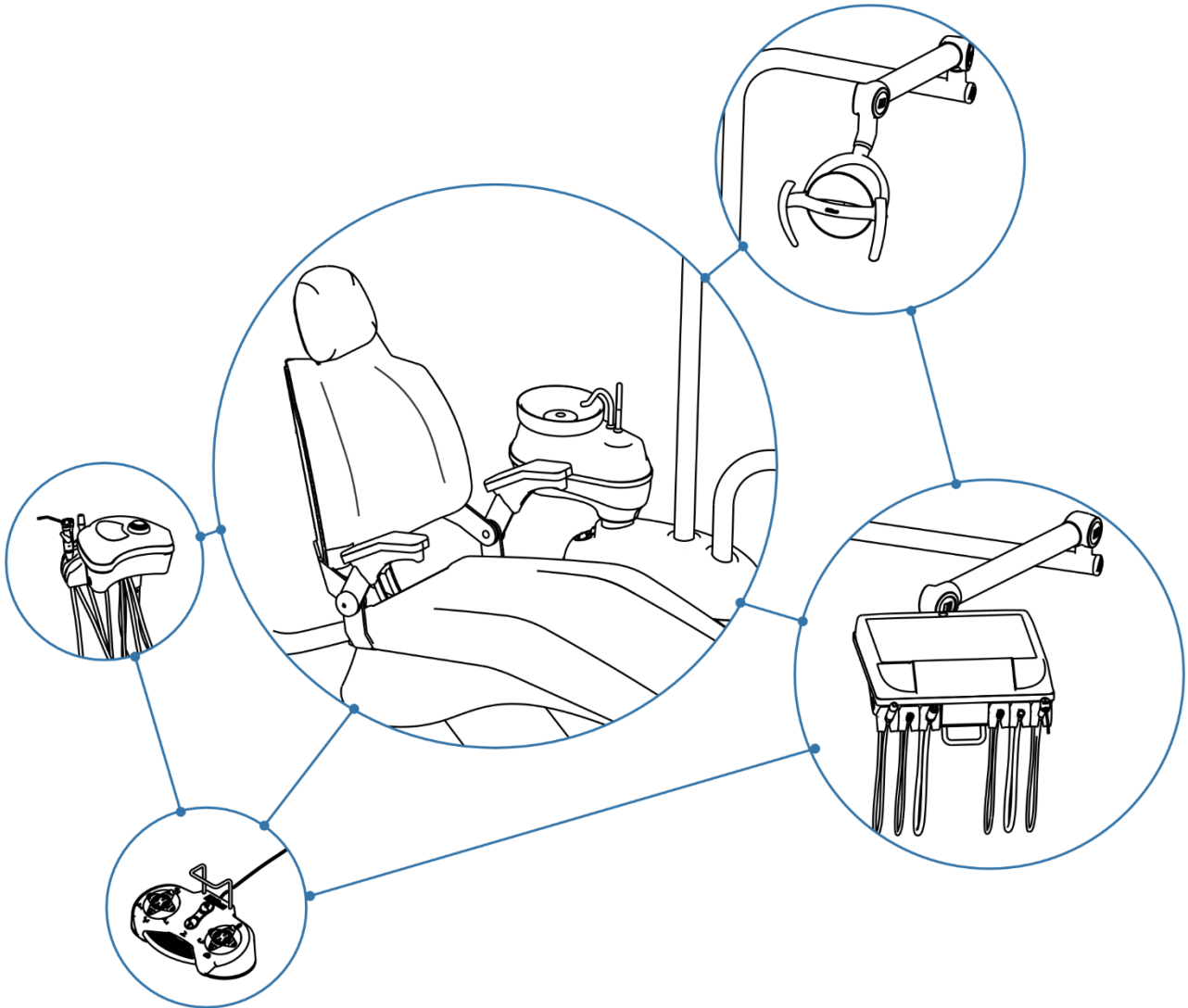

# TABLE OF CONTENTS

1.	INTRODUCTION .....	8
2.	EQUIPMENT DESCRIPTION .....	9
2.1.	Dental Equipment .....	9
2.2.	Operating Principles .....	9
2.3.	Use and Intended User .....	9
2.4.	Package Content .....	9
2.5.	Infinity Line .....	10
3.	SYMBOLS AND WARNINGS .....	11
3.1.	Symbols .....	11
3.2.	Warnings, Notes and Cautions .....	12
4.	PARTS IDENTIFICATION .....	15
5.	TECHNICAL SPECIFICATIONS .....	16
5.1.	Standard Classification of Equipment .....	16
5.2.	Input Characteristics .....	16
5.3.	Environmental Requirements .....	16
5.4.	Equipment Weight .....	16
5.5.	Other Specifications .....	17
5.6.	Applied Parts .....	18
5.7.	Detachable Parts .....	18
5.8.	Accessories .....	18
5.9.	Dimensional .....	19
6.	CHAIR OPERATING INSTRUCTIONS .....	20
6.1.	Beep Warnings .....	20
6.2.	Before Turning on the Equipment .....	20
6.3.	Turning on the Equipment .....	20
6.4.	Positioning of the Patient, Operator and Other Persons .....	21
6.5.	Arm .....	21
6.6.	Headrest .....	21
6.7.	Delivery Unit .....	22
6.8.	Foot Control .....	22
6.9.	Moving the Chair .....	23
6.10.	Emergency Position .....	24
6.11.	Motion Interruption .....	24
6.12.	Movement Blocking System .....	24
6.13.	Anti-Crushing System .....	24
6.14.	Emergency Stop Button .....	24
6.15.	Dental Light .....	25
6.16.	Water Unit .....	27
6.17.	Assistant Module .....	27

## Introduction

6.18.	Working Table .....	28
7.	INSTRUMENT OPERATING INSTRUCTIONS.....	30
7.1.	Pneumatic Coupling.....	30
7.2.	3-Way Syringe.....	31
7.3.	Micromotor .....	31
7.4.	Scaler.....	35
7.5.	Saliva Ejector .....	37
7.6.	Curing Light.....	38
7.7.	Prophylaxis System .....	40
8.	OPERATING INSTRUCTIONS FOR THE ACCESSORIES .....	41
8.1.	Anti-Stress System .....	41
8.2.	Monitor Support.....	41
8.3.	Thermo Comfort .....	42
8.4.	Air Jet System .....	42
8.5.	X-Ray Viewer .....	42
8.6.	ChronoLub System.....	43
8.7.	Kart System.....	45
8.8.	USB Charger.....	45
9.	CLEANING AND DISINFECTION.....	46
9.1.	Technical Barrier .....	46
9.2.	Non-Removable Components .....	46
9.3.	Removable Components.....	46
9.4.	Autoclave Sterilization.....	47
9.5.	Water Tanks and Water Hoses.....	47
9.6.	Internal Suction Hose Cleaning .....	47
9.7.	Filters.....	48
9.8.	Water Unit .....	48
9.9.	Curing Light.....	48
9.10.	Valo Curing Light.....	48
9.11.	Scaler.....	49
9.12.	Daily Procedure to Finalize the Working Day .....	50
10.	INSTALLATION.....	51
10.1.	General Installation Considerations .....	51
10.2.	Pre-installation.....	51
10.3.	Equipment Positioning .....	51
10.4.	Compressed Air.....	51
10.5.	Compressed Air Piping .....	52
10.6.	Water for the Water Unit .....	52
10.7.	Particle Filters.....	52
10.8.	Water to the Reservoir .....	52

## Introduction

10.9.	Water Sample Collection Point.....	52
10.10.	Sewer Network.....	53
10.11.	Amalgam Separator.....	53
10.12.	Vacuum Specifications.....	53
10.13.	Electrical Requirements.....	54
10.14.	Check List.....	54
11.	PREVENTIVE MAINTENANCE PLAN.....	55
11.1.	Maintenance of Electrical and Mechanical Parts.....	56
11.2.	Troubleshooting Table.....	57
11.3.	Installation and Maintenance Registration.....	58
12.	DISPOSAL.....	58
13.	ELECTROMAGNETIC COMPATIBILITY (EMC).....	59
14.	ADVERSE EVENT REPORTING.....	62
15.	WARRANTY.....	62
16.	MESSAGE FROM THE PRESIDENT.....	64

### 1. INTRODUCTION

This manual contains all technical information, descriptions and instructions for use, cleaning, daily care and safety necessary for the operation of the Dental Equipment.

The images used are for illustrative purposes and do not determine the configuration of models or the availability of items and accessories.

#### DOCUMENT

Document identification: Instruction for Use Infinity 5409292

Revision: 03.2.2

Publication date: 21.05.2026

#### COMPLEMENTARY DOCUMENTS

Dental Line Pre-Installation Manual 5409326

Cleaning and Disinfection Guide 5409327

Infinity Quick Operation Guide 5403126

#### EQUIPMENT

Technical name: Dental Chair

Trade name: Dental Equipment

Brand: Olsen

Models: INFINITY, INFINITY PREMIUM, INFINITY PRO, INFINITY PREMIUM PRO, DIAMOND, WORKSTATION, INFINITY PREMIUM CROSS FLEX, INFINITY CROSS FLEX, INFINITY BLACK EDITION, INFINITY BLACK EDITION ELITE, INFINITY BLACK EDITION ELITE CROSS FLEX, INFINITY TITANIUM, INFINITY BLACK EDITION CROSS FLEX.

ANVISA registration 10281300009

#### MANUFACTURER

Olsen Indústria e Comércio S/A

Rua Romalino João da Rosa, 11 – CEIP – Brejaru

CEP 88133-516 – Palhoça/SC – Brazil

Tel.: +55 (48) 2106-6000

[www.olsen.odo.br](http://www.olsen.odo.br)

All rights reserved.

Prior authorization from Olsen Indústria e Comércio S/A is required for reproduction or delivery of any part or all of this manual to third parties.

All technical characteristics, information, functionalities and knowledge described refer to the status of the equipment at the time of publication of this manual. Our policy is one of continuous evolution and development, therefore we reserve the right to make any changes in the equipment and manual without prior notice. Such changes do not result in any right to retrofit existing products.

## 2. EQUIPMENT DESCRIPTION

### 2.1. Dental Equipment

- Upholstery: Mounted on a rigid structure, covered with foam and lined with PVC or seamless leather, providing easy asepsis for the set.
- Mechanical Structure: Made in rolled steel SAE 1020 profiles and steel A36, welded by the MIG/MAG process, in order to guarantee resistance and durability to the set.
- Electrostatic Painting: It is applied to all structural metallic parts of the equipment. The paint is polyurethane based, giving the equipment a highly resistant coating.
- Fairings: Made of high-strength ABS with acrylic coating, the fairings do not require painting and allow for polishing.
- Mains electricity: The equipment can operate in 50 or 60 Hz frequencies and can be configured by an authorized technician for connection in 118/127/220/230 V voltages. The maximum supply voltage for internal components is 24 V. The electrical system has an On/Off switch and protection fuses.
- Motors: All motors used in the equipment are produced by Robert Bosch from Brazil and present differentials such as low noise, absence of oil reservoir, uniformity in displacement, reduction of energy consumption and low maintenance cost. The engines also have a protection system that acts in the mechanical and electrical parts of the set.
- Pressurized Suspension: Logic and Infinity chairs have a high-pressure nitrogen cylinder, which relieves the load on the electromechanical lifting components by 100 kg.
- Instrument Holders: Made of ABS, they have reeds to activate the support valve, which stops the instrument's operation when it is placed in its respective support.
- Automatic Drain Valve: The automatic drain valve has a filter for blocking air humidity and particles. It is installed at the compressed air inlet of the equipment. Automatic draining occurs whenever the compressed air network is depressurized (compressor off) or reaches a pressure below 30 PSI.

### 2.2. Operating Principles

Chair for dental use, performs seat and backrest movements individually and independently through foot pedal driven gear motors or optional control panels of the dental table and auxiliary module. The dental chairs have a single central articulation, aligned with the patient's acetabulum line, providing comfort when moving the backrest.

### 2.3. Use and Intended User

The Olsen Dental Chair is designed to comfortably accommodate the patient for general dental applications. It provides an interface to control dental chair operation and instrument docking. In addition, the equipment is designed to provide air, water, vacuum, and electricity to operate various instruments and accessories. The equipment must be operated only by licensed dentists with higher education, duly qualified and trained to perform dental practices in accordance with current local legislation, and who have full physical and cognitive ability to carry out such practices.

### 2.4. Package Content

The Dental Equipment is supplied in 2 packages of reinforced cardboard with wooden base, one for the chair and the other for the equipment. The availability of the items in the packaging may change according to the client's request. The content present in the packaging includes:

- **Delivery Unit Packing:**

- 1 Delivery Unit;
- 1 Packing Support;
- 1 Dental Stool;
- 1 Dental Light;
- 1 Quick Guide;

- Monitor Support (optional);

- Handpieces (optional);
- Cart system (optional);
- Additional Dental Stool (optional);
- 1 Peripherals Box (headrest, armrest, bowl, stainless steel tray, sewage kit and installation kit).

- **Chair Packaging:**

- 1 Dental Chair;
- 1 Junction Box (optional).

## 2.5. Infinity Line

Group 1:	INFINITY, INFINITY PREMIUM, INFINITY PRO, INFINITY PREMIUM PRO, DIAMOND, WORKSTATION
Group 2:	INFINITY PREMIUM CROSS FLEX, INFINITY CROSS FLEX
Group 3:	INFINITY BLACK EDITION, INFINITY BLACK EDITION ELITE, INFINITY BLACK EDITION ELITE CROSS FLEX, INFINITY TITANIUM
Group 4:	INFINITY BLACK EDITION CROSS FLEX

Below is the equipment configuration table:

Legend	
Not Available	-
Standard Item	●
Optional Item	○
Group 1	1
Group 2	2
Group 3	3
Group 4	4





Chair	1	2	3	4
Premium Soft Upholstery	●	●	●	●
Swivel Armrest	●	●	●	●
Press Click Headrest	●	●	●	●
Foot Control	●	●	●	●
Smooth PVC Upholstery	●	●	●	●
3D PVC Upholstery	○	○	○	○
Leather Upholstery	○	○	○	○
<b>Dental Light</b>				
LED Premium Dental Light	○	○	○	○
Dual Color Dental Light	○	○	○	○
VARI8 Dental Light	●	●	●	●
<b>Working Table</b>				
Flex Support Arm with capacitive handle	●	●	●	●
Cross Flex Table (6 instruments)	-	○	-	○
Cart System	○	-	○	-
<b>Table Instruments</b>				
3-Way Syringe	●	●	●	●
Borden High-Speed Handpiece	●	●	●	●
Borden Low-Speed Handpiece	●	●	●	●
Extra Handpiece (Low or High Speed)	○	○	○	○
Brushless Micromotor	○	○	○	○
Scaler with LED	○	○	○	○
Olsen Corded Light-Curing Unit	○	○	○	○
Valo Cordless Light-Curing Unit	○	○	○	○
Bicarbonate Jet	○	○	○	○
<b>Water Unit</b>				
Bowl Water - with timer	●	●	●	●
Cupfill Water - with timer	○	○	○	○
Polyester Bowl	●	●	●	●
Assistant Module	●	●	●	●

Auxiliary Module Instruments	1	2	3	4
3-Way Syringe	●	●	●	●
Venturi Ejector	●	●	●	●
Vortex Ejector	○	○	○	○
Vacuum Pump Ejector	○	○	○	○
Curing Light Olsen	○	○	○	○
Curing Light Valo	○	○	○	○
Bicarbonate Jet	○	○	○	○
<b>Coupling</b>				
Borden Coupling with cooling	●	●	●	●
Borden Coupling with fiber optic	●	○	●	○
Midwest Coupling	○	○	○	○
Midwest Coupling with fiber optic	○	○	○	○
<b>Accessories</b>				
Anti-stress	○	○	○	○
Thermo Comfort	●	●	●	●
X-Ray Viewer	○	○	○	○
USB port	●	●	●	●
Chronolub System + Heart Monitor	○	-	○	-
Monitor Support	○	○	○	○
Junction Box	○	○	○	○
Junction Box for Kart	○	○	○	○
Air Filter (Drain)	○	○	○	○

### 3. SYMBOLS AND WARNINGS

#### 3.1. Symbols

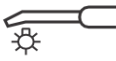
The following symbols are used in the document and on product and packaging markings:

 Chair Up	 Chair Down	 Zero Position
 Backrest Up	 Backrest Down	Work Position
 Bowl Flush	 Cup Filler	 Multifunction Syringe (Air-water)
 Dental Air Motor	 Turbine	 Turbine with Illumination
 Dental Low Voltage Electric Motor	 Ultrasonic Scaler	 Curing Light
 Saliva Ejector	 Suction Handpiece	 Suction Handpiece with Hand Control Valve
 Variability, for Rotating Movement	 Dental Operating Light	 Lighting
 Freio Pneumático	 Hand Control Valve	 Foot Switch
 Spray-cooling	 OFF	 Anti-Stress
 Stop	 ON	 ON (Part of the Equipment)
 Emergency Stop	 ON / OFF	 OFF (Part of the Equipment)
 Manufacturer	 Caution	 Write Data into Store (Selection)
 General Warning Sign	 Level	 Warning, Electricity

## Introduction

 Operating Instructions	 General Prohibition Sign	 Sterilizable Up to the Temperature Specified
 General Mandatory Action Sign	 Stepping Prohibited	 Refer to the Instruction Manual
 Type B Applied Part	 Type BF Applied Part	 Information Note
 Earth (Ground)	 Keep Away from Heat	 Protective Earth (Ground)
 Fragile, Handle with Care	 Temperature Limitation	 Humidity Limitation
 Heaping Up	 This Side Up	 Keep Dry
 Non-Sterile	 Serial Number	 Alternating Current



Authorized Representative in the European Community

### 3.2. Warnings, Notes and Cautions



Follow the instructions in the Installation section for the correct installation of the equipment.



Properly follow the operating instructions contained in the document. Incorrect use may bring safety risks and damage to the equipment that will not be covered by the warranty.



Clean the equipment properly according to the instructions in the Cleaning and Disinfection section.



Protect equipment from direct sunlight to prevent premature aging of equipment fairings.



Before starting activities in the office, check the conditions of the compressor, observe its operation until its first automatic shutdown. Then close the air reservoir drain.



At the beginning of the activities in the office, check the autoclave.



Before using the equipment, check daily and drain the compressor and equipment moisture filters when necessary, such as: drain valve, prophylaxis system filter, compressed air line filter.



Observe the external corrugated hoses of the equipment, positioning them in order to avoid being crushed when executing the Zero Position or Chair Down command.



To isolate the equipment from the power supply, turn off the equipment's power supply circuit breaker.



Interruption of the operation of any part of the equipment, whether electrical, hydraulic, pneumatic or suction, does not generate any unacceptable risk, because dental equipment does not provide life support (it has no essential performance).



Prevent objects, equipment parts or dental stool casters from being on the hoses. This may cause damage to the equipment and its proper functioning.



The mains cable and the scaler transducer are designed for exclusive use on the Olsen Chair. The use of these components in other equipment or different from those specified may compromise the emissions and electromagnetic immunity of the equipment.



Do not use the equipment with water pressure, compressed air or electrical voltage outside the specifications shown. This could cause it to lose its functionality. Equipment defects resulting from the use of equipment outside of its specifications will not be covered by the warranty.



This equipment must only be operated by properly qualified professionals, according to the local standards.



Before using any instrument, be sure to test its operation outside the patient's oral cavity. If you detect any abnormality, stop using it immediately and contact an accredited service center.



Do not replace electrical protection fuses while the equipment is on. Risk of electric shock!



Do not remove the casings from the equipment. Risk of electric shock! Only an Olsen authorized technician can perform this type of procedure.



Do not operate the equipment with mechanical and/or electrical malfunctions.



This equipment is contraindicated for any use or user other than its intended use.



Do not perform the following procedures if it is possible to touch the patient, even unintentionally:

- Replacing fuses;
- Connecting or disconnecting the equipment to the power supply network;
- Any repair or maintenance procedure;
- Cleaning and disinfection procedures;
- Fitting or removing the electric micromotor from its coupling;
- Attachment or removal of the scaler from its coupling;
- Attachment or removal of the high-speed fiber optic instrument from its coupling.

### 3.2.1. Transport and Storage



It is recommended that the equipment be transported and stored in its original packaging;



Transport carefully, protecting the equipment from falls and impacts.



Protect from humidity, exposure to rain and direct contact with liquids.



Keep under cover of the sun.



Respect the maximum stacking of up to 4 volumes.



Temperature range for transport and storage: -12° C to +50° C.



Humidity limits for transportation and storage: 20% to 70%.



Do not move and do not store the equipment on uneven surfaces.



Lift the chair only by its base.



Caution! Do not remove the product from the packaging outside the environment intended for use.

#### 4. PARTS IDENTIFICATION

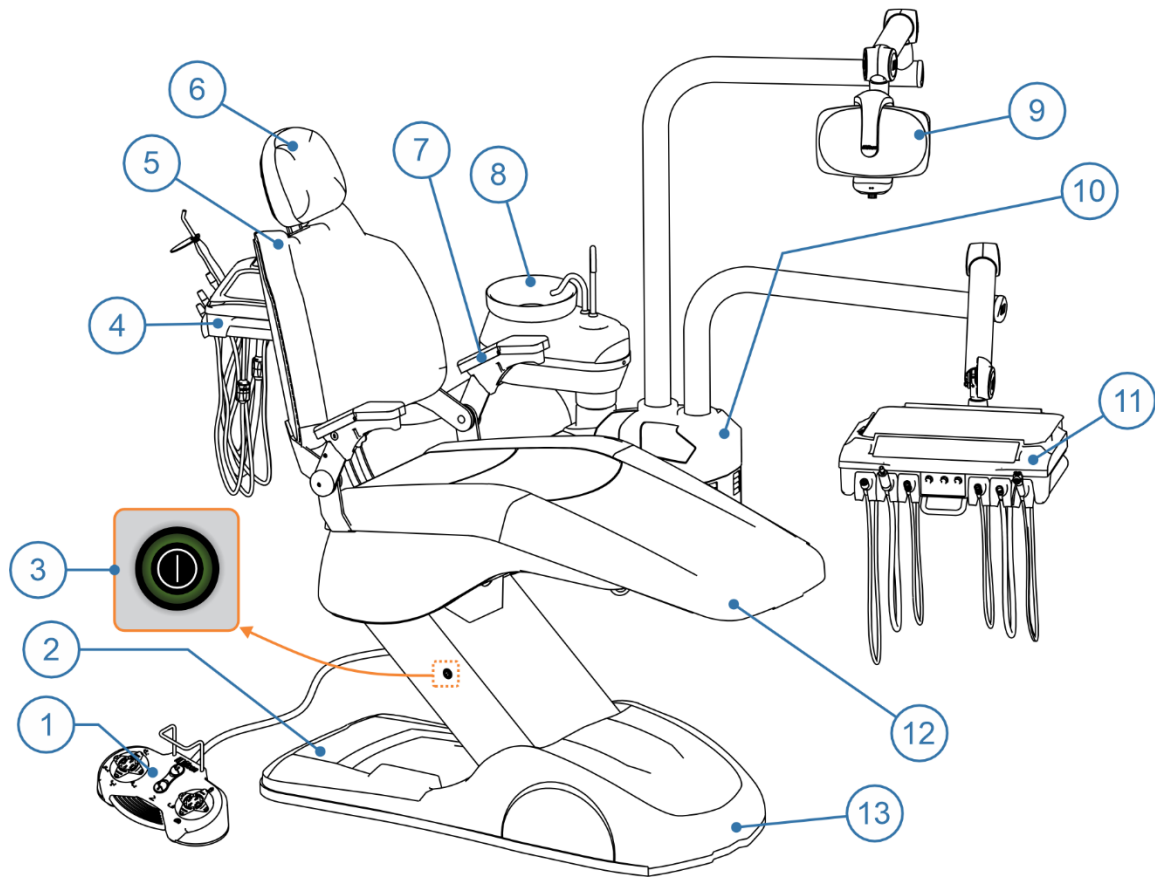

1 – Foot Controls;

2 – Chair Base;

3 – On/Off Switch;

4 – Assistant Module;

5 – Backrest;

6 – Headrest;

7 – Armrest;

8 – Water Unit;

9 – Dental Light;

10 – Delivery Unit;

11 – Working Table;

12 – Seat;

13 – Junction Box.

## 5. TECHNICAL SPECIFICATIONS

### 5.1. Standard Classification of Equipment

<b>Protection against electric shock:</b>	
Class I Equipment - Type B	
<b>Degree of Application Safety in the Presence of Flammable Anesthetic Mixture:</b>	
Equipment not suitable for use in the presence of a flammable mixture with air, oxygen or nitrous oxide	
<b>Use in an Oxygen-Rich Environment:</b>	
Equipment not suitable for use in an oxygen-rich environment	
<b>Operation Mode:</b>	
<b>Non-Continuous</b> Chair: on 30 s, off 5 min. Curing Light: on 40 s, off 5 min. Bowl flush water (with timer): on 15 s, off 5 min. Cup filler water (with timer): on 4 s, off 5 min. Anti-Stress: on 15 min, off 10 min.	<b>Continuous</b> Dental Light, Thermo Comfort, ChronoLub System, Scaler, Fiber Optic Light, X-Ray Viewer, and Electric Micromotor.
<b>IP Protection:</b>	
Equipment: IPX0	Foot Control: IPX1

### 5.2. Input Characteristics

<b>Nominal Voltage:</b>	118 / 127 V~	220 / 230 V~
Power:	200 VA	250 VA
Fuse:	F 3 A H (5x20 mm)	F 1,5 A H (5x20 mm)
Frequency:	50 / 60 Hz	
Number of Phases:	Single-phase	

### 5.3. Environmental Requirements

Limits	Description
Operating Environment:	Temperature: Between 15 and 28° C
	Atmospheric Pressure: Between 75 and 106 kPa
	Humidity: Between 30 and 70% without condensation
Transport and Storage:	Temperature: Between -12 and +50° C
	Atmospheric Pressure: Between 75 and 106 kPa
	Humidity: Between 20 and 70% non-condensing

### 5.4. Equipment Weight

Model	Net			Gross		
	Chair	Delivery	Total	Chair	Delivery	Total
Infinity (all models)	180 kg	100 kg	280 kg	230 kg	130 kg	360 kg

### 5.5. Other Specifications

Part of the Equipment	Specification
Transformer Thermal Protection	Opening at 130°C (±3%)
Maximum Work Load	Patient: 150 kg
	Patient + Accessories: 157,5 kg
	Patient + Accessories + Equipment: 385,5 kg
Capacity of Each Reservoir	1000 ml
Size of the Connections	Electrical: ¾" flexible conduit
	Air: ¾" flexible conduit
	Water: rigid weldable PVC tube Ø25 mm, with L/R termination 25x½"
	Sewer: DN Ø40 mm
Internal Hose Color	Blue: air
	Green: water
	Transparent: sewer
Fuse for Connection Box	118/127/220/230 V~ Fuse F 10 A H (5x20 mm)
Scaler	Manufacturer: Guilin Woodpecker Medical Instrument Co.
	Model: UDS-N3 LED
	Degree of Protection: Type B
Working Table Tray	Maximum weight supported by the tray: 2 kg

#### 5.5.1. Dental Light

Model	Illumination	Color Temperature	Compatibility with restorative materials	Illumination level at the point A
Evolution Plus	8000 - 30000 LUX	4500 K *	NA	~380 LUX
Concept Plus	8000 - 30000 LUX	5000 K *	NA	~500 LUX
LED Premium	8000 - 30000 LUX	5000 K *	NA	~220 LUX
Dual Color	7000 - 30000 LUX	3500 / 5500 K *	3500 K	~200 LUX
VARI8	6000 - 41000 LUX	2000 K, 4000 K, 4500 K, 5000 K, 6000 K *	2000 K	~200 LUX

\*The color temperature may vary slightly due to the variation in dental light intensity.

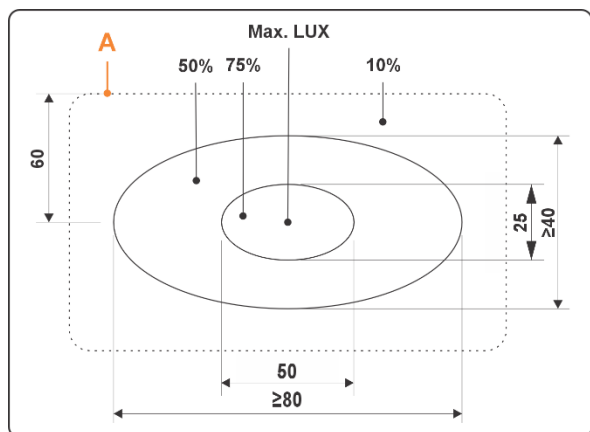

Illumination Pattern

## Technical Specifications

### 5.6. Applied Parts

- Upholstery (armrests, backrest and seat);
- Curing Light Tip;
- Scaler Tip;
- Heart Monitor Sensor.

### 5.7. Detachable Parts

- Dental light polycarbonate protection shield;
- Multi-articulated Headrest;
- Cardiac Monitor Connector;
- Fiber optic tip of the curing light;
- Light hood of the curing light;
- Scaler tips;
- Scaler transducer;
- Bicarbonate jet handpiece;
- Bicarbonate reservoir cover;
- 3-way syringe tip;
- Water tanks;
- Venturi ejector connector;
- Stainless steel tray;
- Spittoon bowl;
- Bowl flush water spout;
- Cup filler water spout;
- Electric micromotor;
- LED Premium dental light side handles;
- Concept Plus dental light side handles;
- Dual Color dental light side handles;
- VARI8 dental light side handles.

### 5.8. Accessories

- Monitor support;
- Monitor;
- Cart System;
- Low-speed handpieces;
- High-speed handpieces.

### 5.9. Dimensional

The dimensions below meet all models of the Infinity line.

Measures in millimeters

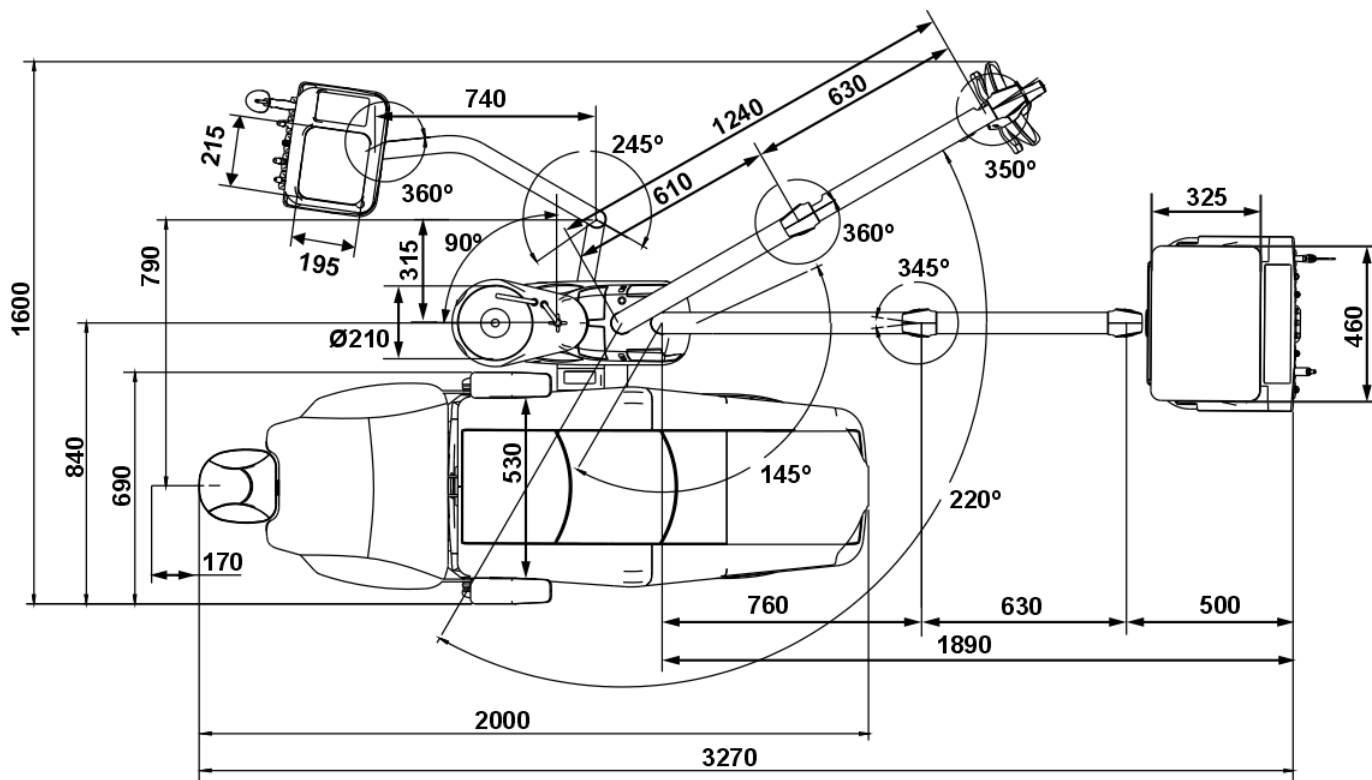
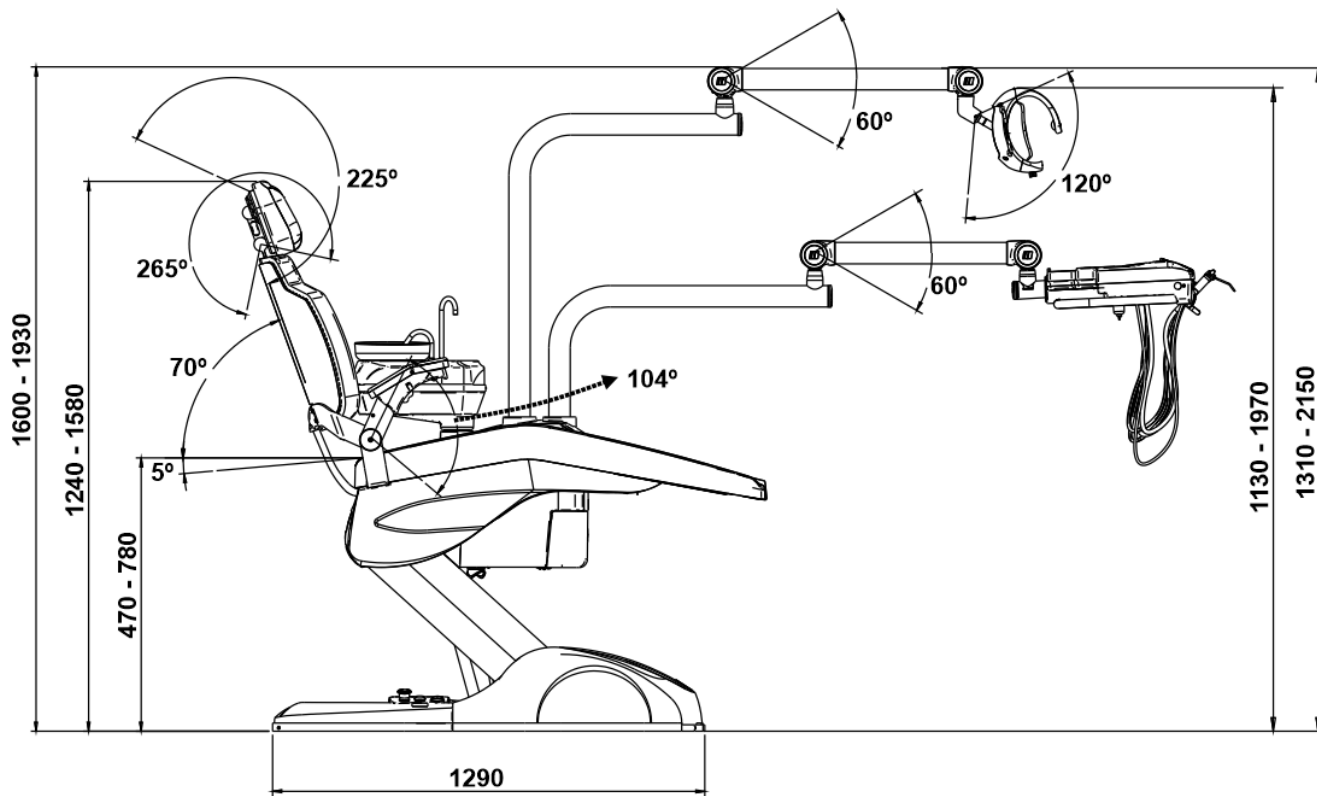

## 6. CHAIR OPERATING INSTRUCTIONS

### 6.1. Beep Warnings

The equipment's beep warnings are interpreted according to the table below:

Beep Warnings	Definition
1 short beep and 1 long beep	<ul style="list-style-type: none"> <li>◦ When you turn on the equipment;</li> </ul>
1 short beep	<ul style="list-style-type: none"> <li>◦ When pressing the Work Position command;</li> <li>◦ When pressing the command turn on the dental light;</li> <li>◦ When touching the buttons on the VARI8 dental light.</li> <li>◦ When reaching the illumination limits of the Dual Color and VARI8 dental light.</li> <li>◦ At the end of the return from the Spit Position.</li> <li>◦ Selection of the 1st vibration stage of the anti-stress (light vibration).</li> </ul>
2 short beeps	<ul style="list-style-type: none"> <li>◦ When selecting spit position or Work Position;</li> <li>◦ When you press the Zero Position command;</li> <li>◦ Upon reaching the limits (min. and max.) of illumination of the LED Premium dental light.</li> <li>◦ Selection of the 2nd vibration stage of the anti-stress (medium vibration).</li> </ul>
3 short beeps	<ul style="list-style-type: none"> <li>◦ Canceling continuous or automatic movements;</li> <li>◦ End of time for work position selection or saving.</li> <li>◦ Selection of the 3rd vibration stage of the anti-stress (strong vibration).</li> </ul>
2 long beeps	<ul style="list-style-type: none"> <li>◦ Interval for work position recording.</li> </ul>

### 6.2. Before Turning on the Equipment

- Check that the equipment is properly installed, according to the instructions in the Installation section;
- Turn on the compressor that supplies the equipment;
- Open the equipment's water supply register;
- Turn on the equipment's power supply circuit breaker.

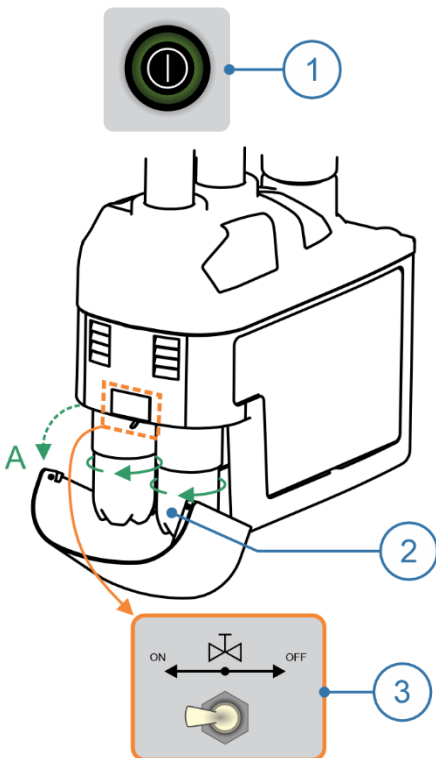

### 6.3. Turning on the Equipment

- Turn on the On/Off Button (1) located on the base of the chair.
- Operate the Chair Up button on the foot pedal until the chair reaches its maximum height limit;
- Open the lid of the tanks compartment (A) and close the Pressurization Valve (3) located near the tanks;
- Check if the Water Tanks (2) are full. If necessary, fill them with mineral or filtered water up to the limit indicated in each tank and connect them again to the equipment. If desired, add prophylactic products of low concentration;
- Open the Pressurization Valve (3) and check if the Water Tank (2) are well coupled and without leaks;
- Before starting to use the equipment, check the operation of all the instruments and controls available and clean and sterilize the instruments according to the Cleaning and Disinfection section.



The second water tank is part of the structure depending on the equipment configuration.

### 6.4. Positioning of the Patient, Operator and Other Persons

The patient must sit and support his or her legs along the seat of the chair, back on the backrest and forearms on the armrest of the chair or on the body itself. The operator must adjust the headrest according to the dental procedure to be performed.

To ensure the safe and proper positioning of the patient, the operator must guide the patient to keep his or her hands within the operator's field of vision during the entire movement of the equipment.

The operator must position himself near the headrest or the backrest sides, observing the necessary distance to perform the dental procedures. To move the seat and the backrest, it is recommended that the operator maintain a minimum distance of 30 cm, avoiding positioning himself in the line of movement of these items of the chair.

Other people must keep a minimum distance of 50 cm from the equipment when moving the backrest and seat.



**The permanence of the operator, people or objects in the movement areas of the equipment and its components can cause damage to the equipment and/or impair its correct operation.**

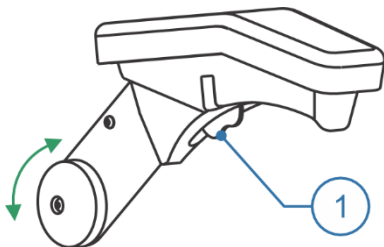

### 6.5. Arm

Item for accommodating the patient's arm.

**To move the swiveled arm:** press the Lever (1) located on the bottom. Only the arm opposite the Delivery Unit can have this movement option.

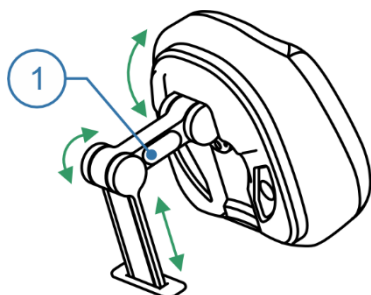

### 6.6. Headrest

The function of the headrest is to accommodate the patient's head for clinical and surgical procedures.

#### **Press Click Headrest:**

**Adjust angle:** keep the button (1) pressed down while making the adjustment. Release the button (1) to lock in position.

**Adjust height:** pull or push the headrest away from or toward the backrest. Do not exceed a distance of 10 cm between the headrest and the backrest.

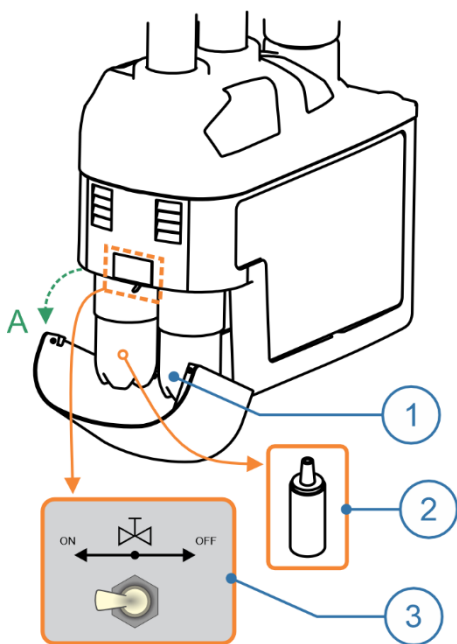

### 6.7. Delivery Unit

The unit holds the Water Unit, the Assistant Module, the Dental Light, the Foot Controls, and the Working Table.

A Pressurization Valve (3) and a Water Tank (1) with a Solid Waste Filter (2) are provided on the delivery unit to prevent clogging in the instrument irrigation system.

To access the tanks and the pressurization valve, pull the cover (A). It is attached by magnets, making it easy to open and close.

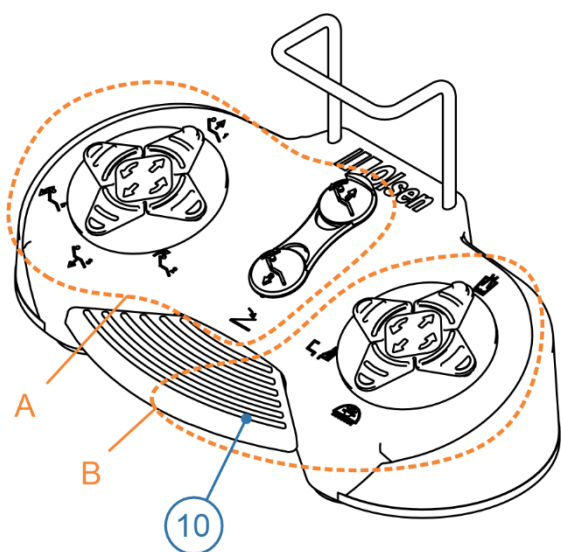

### 6.8. Foot Control

The Foot Control shows the equipment's controls and a Handle to facilitate its movement with the feet.

#### Chair Movement (A):

- 1 - Chair Up / Position 1;
- 2 - Backrest Up / Position 2;
- 3 - Chair Down / Position 3;
- 4 - Backrest Down / Position 4 (Spit Position);
- 5 - Zero Position;
- 6 - Work Position.

#### Equipment and Instruments (B):

- 7 - Water in the bowl;
- 8 - On/Off Dental Light;
- 9 - Water in the Cupholder;
- 10 - Propulsion Button.

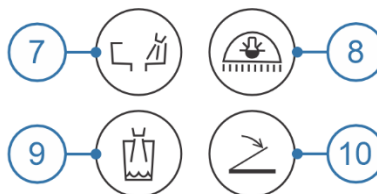
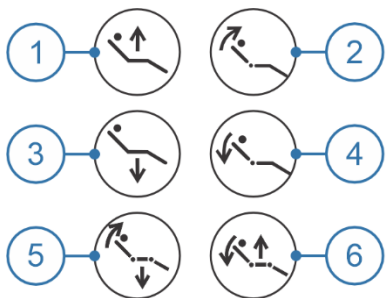

### 6.9. Moving the Chair



Use the movement buttons on the Foot Control or Control Panel to perform the operations described below.

**Moving the backrest:** press the Backrest Up (2) or Backrest Down (4) button until you reach the desired position.

**Moving the chair:** press the Chair Up (1) or Chair Down (3) button until you reach the desired position.

**Zero Position:** Press the Zero Position button (5) to automatically adjust the seat to the lowest position and the backrest to the highest position simultaneously.

**Work Position:** To facilitate moving the backrest and chair into a certain position, there are 4 positions that can be actuated. The Position number is indicated on the upper right corner of the backrest and chair movement buttons (A).

**Position 1, 2 and 3** are recorded by the user. The backrest and seat move simultaneously to the previously recorded position, and the dental light is turned on at the last light intensity used.

**Position 4** is the Spit Position. It cannot be changed.

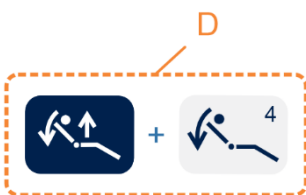
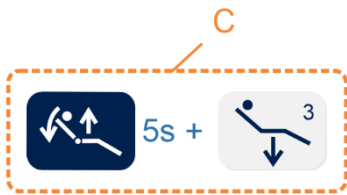
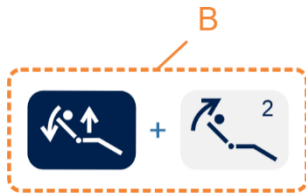

**1. Execute a Work Position (B):**

- a) Press the *Work Position* button (6). The equipment will emit 1 short beep;
- b) Press the desired *Position* button (1, 2, 3 or 4). The equipment will beep twice confirming the operation. The time to select the position is 4 seconds. If no button is pressed within this period, the equipment cancels the operation.

**2. Save a Work Position (C):**

- a) Press the *Zero Position* button (5);
- b) Adjust the backrest to the desired position;
- c) Adjust the chair to the desired position;
- d) Press the *Work Position* button (6) for 5 seconds. The equipment will go into record mode for the next 2 seconds, emitting 2 long beeps. Perform the next step within this interval. Otherwise, the equipment will emit 3 short beeps, canceling the operation;
- e) Choose one of the *Position* buttons (1, 2 or 3) to record the adjusted position. The equipment will emit 2 short beeps to confirm that the position has been recorded.

**Spit Position (D):** When pressing the Spit Position, the dental light turns off, raises the backrest, and activates water in the bowl. After 8 seconds, the equipment returns to the previous position.

### 6.10. Emergency Position

The Backrest Down control, in the maximum recline position, provides cerebral irrigation by gravity. The maximum recline is -5 degrees from horizontal.

### 6.11. Motion Interruption

The equipment that feature automatic commands such as Work Position and Zero Position have the movement stopped immediately with the execution of any chair movement control, either on the foot control or control panels. When canceling an automatic movement, the equipment beeps three times.

If the operator sees any situation that could create some kind of risk to the patient, he/she must stop moving the equipment immediately.



**The operator must supervise all execution of automatic equipment movements.**

### 6.12. Movement Blocking System

While the propulsion control is actuated, all chair movements are blocked, so that there is no accidental movement.

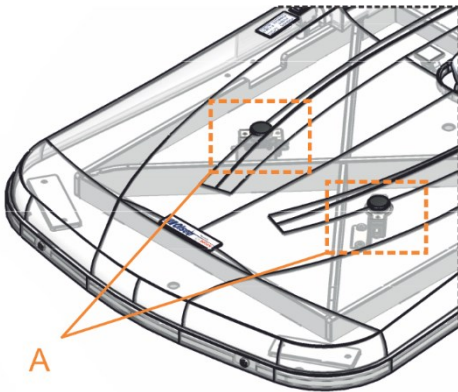

### 6.13. Anti-Crushing System

Consists of devices (A) located at the base of the chair that, when activated, stops the Chair Down movement and performs the Chair Up movement for 4 seconds, beeping for 10 seconds. This system prevents any object or body part on the base of the chair from being crushed.

After the anti-crushing system is activated, the equipment will not allow the use of the control commands again. To do this, turn the unit off and on again.

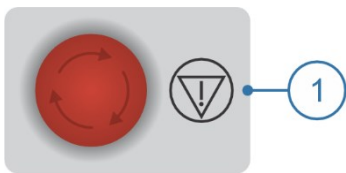

### 6.14. Emergency Stop Button

The *Emergency Stop Button (1)* interrupts the power to the entire equipment and consequently stops any chair movement while it is running. Press the button to activate it. Turn the button clockwise to deactivate it.



**The emergency stop button must be deactivated for equipment operation.**

### 6.15. Dental Light

The dental light has a multifaceted mirror for shadow elimination, gradual and cyclical intensity control, articulated arms, and side handles for positioning adjustment.

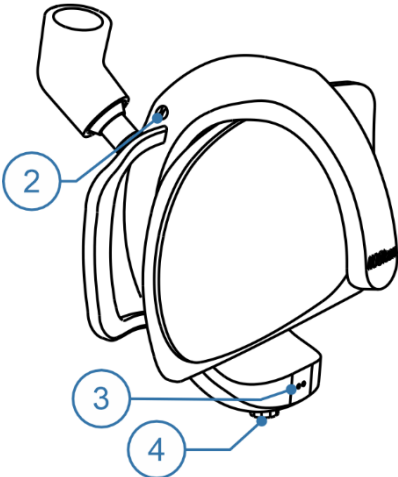
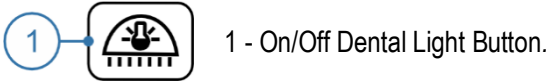

#### 6.15.1. LED Premium

The LED Premium Dental Light features indirect LED illumination in a sealed compartment, directed to the multifaceted mirror. It has a proximity sensor and control knob in the bottom. Its Handles can be removed by removing the Fixing Screws (2).

**On/Off:** press the Dental Light On/Off button (1), or move your hand in front of the Sensor (3) approximately 5 cm away, or press the Control Knob (4). The controls on the light head are enabled only when the dental light button (1) is turned on.

**Adjust lighting intensity:** keep your hand in front of the Sensor (4), or turn the Control Knob (2) to the right or left, until the dental light reaches the desired intensity.

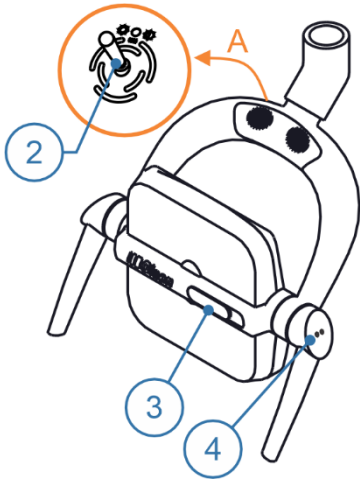

#### 6.15.2. Dual Color

Dental light with indirect illumination through a multifaceted mirror, compatible with light-cured restorative materials, with gradual intensity control via proximity sensor or switch located behind the dental light (A).

**On/Off:** press the Dental Light On/Off button (1), or move your hand in front of the Sensor (4) at approximately 5 cm distance, or move the Switch (2) laterally to the right or left. The controls on the light head are enabled only when the dental light button (1) is turned on.

**Adjust light intensity:** keep your hand in front of the Sensor (4) at approximately 5 cm distance, or hold the Switch (2) laterally to the right or left, until the dental light reaches the desired intensity.

**Color temperature adjustment:** slide button (3) to the right (white light) or to the left (yellow light) to select the desired color.

**Compatibility with light-cured materials:** slide button (3) to the left to select yellow light.



**Never perform procedures with light-cured restorative materials without first correctly adjusting the dental light settings. Use yellow light for procedures with light-cured materials and white light for normal working procedures.**

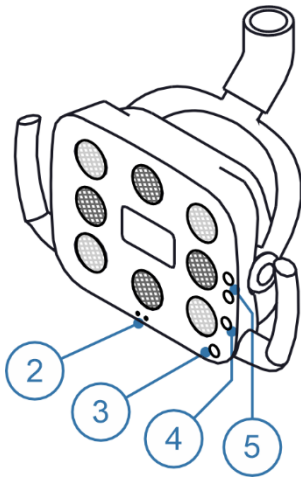

### 6.15.3. VARI8

Dental light with direct illumination through 8 LEDs (4 white and 4 yellow), compatible with light-cured restorative materials, with gradual intensity control via touch-sensitive buttons or proximity sensor.

**On/Off:** press the Dental Light On/Off button (1), or move your hand in front of the Sensor (2) at approximately 5 cm distance, or touch button (3). The controls on the light head are enabled only when the dental light button (1) is turned on.

**Adjust light intensity:** keep your hand in front of the Sensor (2) at approximately 5 cm distance, or touch the plus or minus button (5) until the dental light reaches the desired intensity.

**Color temperature adjustment:** touch button (4) to change the color temperature cyclically (2000–4000–4500–5500–6000 K).

**Compatibility with light-cured materials:** touch button (4) until selecting 2000 K (yellow light).



**Never perform procedures with light-cured restorative materials without first correctly adjusting the dental light settings. Use yellow light for procedures with light-cured materials and white light for normal working procedures.**

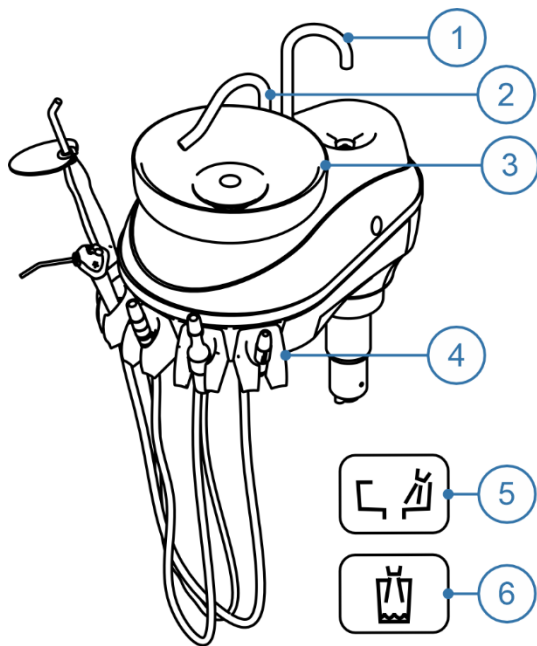

### 6.16. Water Unit

The main function of the water unit is to provide a water point and drainage connection to assist in the performance of dental procedures.

The water unit is foldable up to 90° and provide a bowl (3) that is easy to remove for cleaning.

The water ducts of the bowl (2) and the Cupholder (1) are detachable to facilitate the cleaning process of the unit.

As for the water controls, the unit can have a timed control on the unit itself, or activation buttons on the foot control or control panel.

Optional Instrument Holders (4) such as Saliva Ejector, Light Curing, Prophy-Jet, High Rotation Coupling, and 3-Way Syringe can be provided on the water units.

**Activate water in the bowl:** press the Water in the Bowl button (5).

**Activate water in the cupholder:** press the Water in the Cupholder button (6).

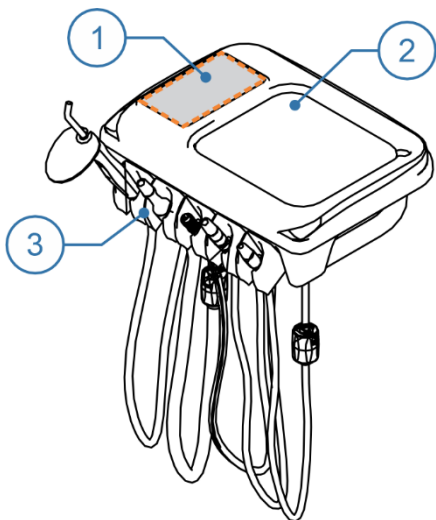

### 6.17. Assistant Module

The Assistant Module, through its extension arm, allows the approximation of the saliva ejectors, 3-way syringe, and other accessories so that the professional can reach them, even when working in a 9 o'clock position.

The Assistant Module can feature Holders (3) for optional Instruments such as Saliva Ejector, Light Curing, Bicarbonate Jet, High Rotation Coupling, and 3-Way Syringe.

Besides the instruments, the assistant module can feature as optional extras Control Panel (1) stainless steel tray (2).

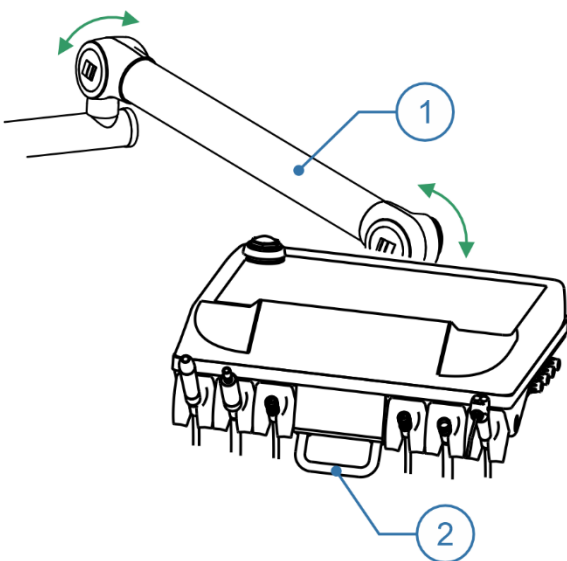
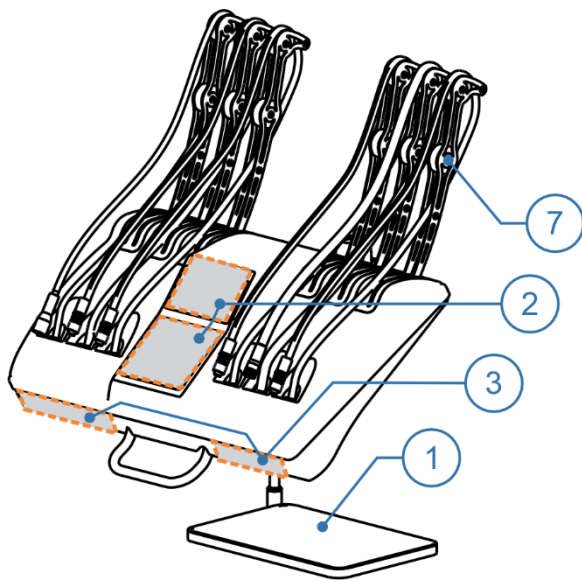
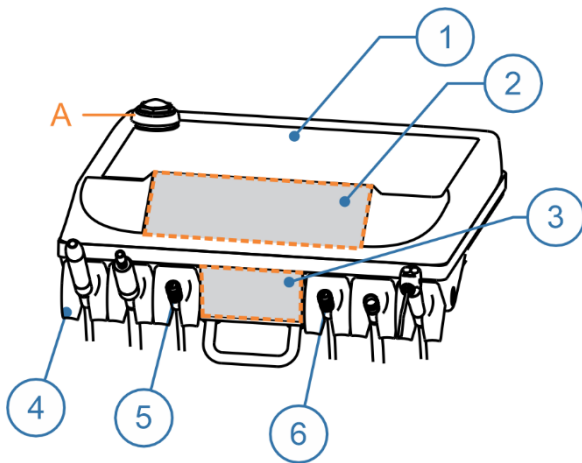

## 6.18. Working Table

The function of the working table is to provide instruments for performing dental procedures. The instruments are arranged in holders (4), or, in the case of the Cross Flex model, in Retractable Rods (7). The working table has a stainless steel tray (1) to support the instruments.

The working table has a 3-way syringe and Borden pneumatic couplings for low and high-speed handpieces.

As optional items, the working table can offer Midwest couplings, Instrument Panel (3), and Control Panel (2) that control parts of the equipment such as Chair Movement, Water Unit, Dental Light, and Accessories activation.

The availability and arrangement of the buttons on the Control Panel and Instrument Panel varies according to the chosen configuration of the equipment.

**Arrangement of the pneumatic couplings:** by default the working table provide the first pneumatic coupling, from left to right, for coupling the low speed handpiece / pneumatic micromotor (5) and the other couplings are for high-speed handpieces.

This sequence **does not apply** when the table features Built-In Bicarbonate Tank (A). In this case the first pneumatic coupling (5) is for the Bicarbonate Jet handpiece and the second is for the low speed handpiece (6). The other couplings are for high-speed instruments.



**The maximum weight supported by the tray is 2 kg. Do not exceed this value.**



**Do not use high-speed handpieces attached to the low speed coupling. This will cause damage to the instruments.**

### 6.18.1. Support Arm

The support arm allows the free horizontal movement of the working table and has the following characteristics:

#### Flex Arm

The Flex Arm (1) has 2 articulations and a pneumatic brake system that is deactivated by touching the Capacitive Handle (2), releasing the table movement.



**Do not move the working table vertically without disabling the pneumatic brake. This may damage the locking system.**



### 6.18.2. Control Panel

#### Chair Movement:

- 1 - Chair Up / Position 1;
- 2 - Backrest Up / Position 2;
- 3 - Chair Down / Position 3;
- 4 - Backrest Down / Position 4 (Spit Position);
- 5 - Zero Position;
- 6 - Work Position.

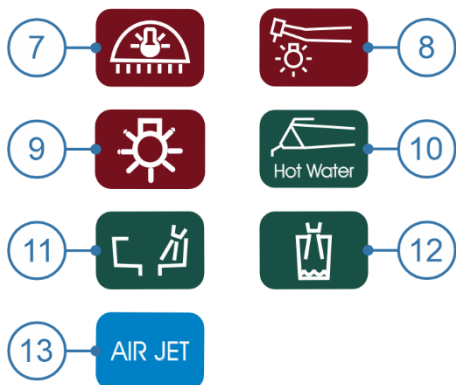

#### Equipment, Instruments and Accessories:

- 7 - On/Off Dental Light;
- 8 - On/Off Fiber Optic Light;
- 9 - On/Off X-Ray Viewer;
- 10 - On/Off Thermo Comfort;
- 11 - Water in the Bowl;
- 12 - Water in the Cupholder;
- 13 - On/Off Air Jet.



#### ChronoLub System:

- 14 - Up;
- 15 - Down;
- 16 - Adjust/Enter;
- 17 - Reset/Esc.

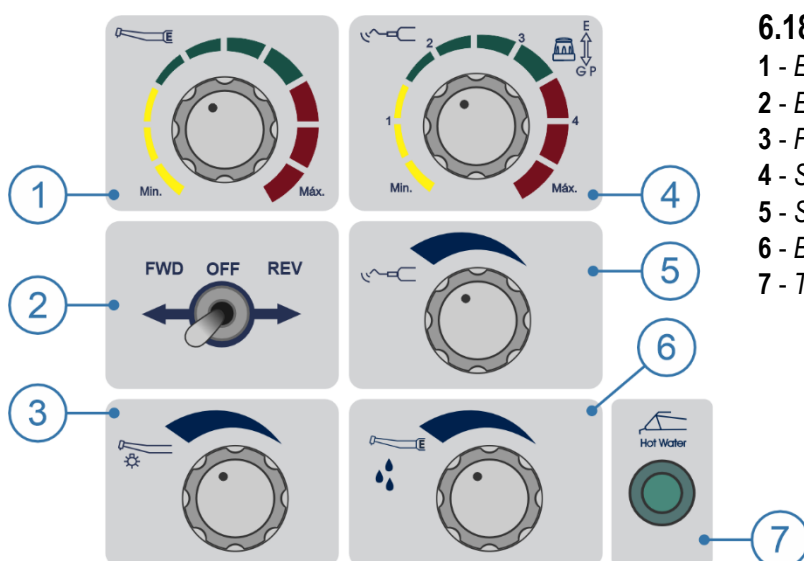

### 6.18.3. Instrument Panel

- 1 - Electric Micromotor - Speed Adjustment;
- 2 - Electric Micromotor - Rotation Inverter;
- 3 - Fiber Optics - Water Adjustment;
- 4 - Scaler - Power Adjustment and Function Selector;
- 5 - Scaler - Water Adjustment;
- 6 - Brushless Micromotor - Water Adjustment;
- 7 - Thermo Comfort - On/Off Indicator.

## 7. INSTRUMENT OPERATING INSTRUCTIONS

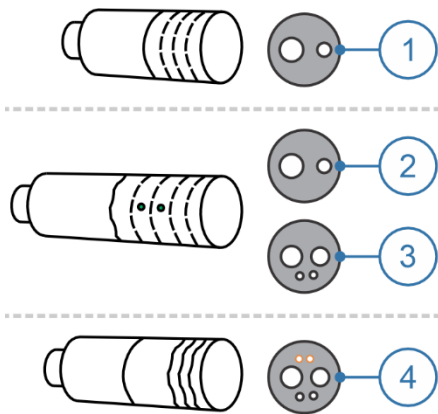

### 7.1. Pneumatic Coupling

By default, Olsen uses the Borden coupling system on its equipment, with the Midwest system available as an option.

The initial version of the coupling is the Borden Without Cooling (1), used only for coupling low speed handpieces.

The Borden Coupling with Cooling (2) allows for spray adjustment and is an optional item, as well as the Midwest Coupling (3), which is also cooled and has a propulsion air deviation system that does not return to the operator's hand. These couplings can be disassembled for cleaning without the use of specific tools.

The Midwest Coupling with Fiber Optics (4) is also an optional item and features 3.1 V power supply for turbine with fiber optic lighting.



**The pneumatic system is configured to allow enough pressure to activate only one instrument at a time. If any instrument is not properly fitted in its holder or the retractable rods is partially extended, this may cause air leaks through the coupling, lowering the correct pressure and flow for operation.**

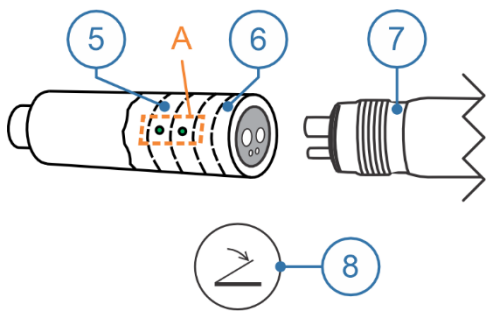

#### 1. Borden/Midwest Coupling with Cooling:

Connect the Handpiece (7) to the coupling, attaching it with the Coupling Ring (6), checking that it is well connected and that there are no air or water leaks.

**Activate rotation:** Press the Propulsion Button (8) on the foot control. The more pressure you apply to the Propulsion Button, the faster the handpiece rotates.

**Adjust spray:** Turn the Adjustment Ring (5) until the desired water volume is obtained. To adjust the maximum water flow bring the Adjustment Points (A) closer to each other. To decrease the water flow, turn the Adjustment Ring (5) away from each other. Totally opposite Adjustment Points (A) indicate the minimum water setting for the spray.

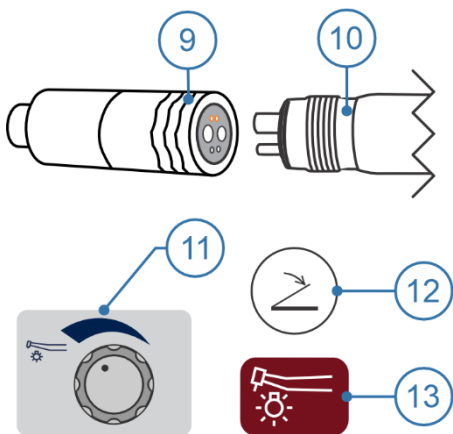

#### 2. Midwest Coupling with Fiber Optics:

Connect the Fiber Optic Handpiece (10) to the coupling by attaching it with the Coupling Ring (9), checking that it is well connected and that there are no air or water leaks.

**Activate rotation:** Press the Propulsion Button (8) on the foot control. The more pressure you apply to the Propulsion Button, the faster the handpiece rotates.

**On/Off Fiber Optic Light:** Use the Fiber Optic Light On/Off button (13) on the control panel.

**Adjust spray:** Use the Fiber Optic Water Adjustment knob (11) on the instrument panel.

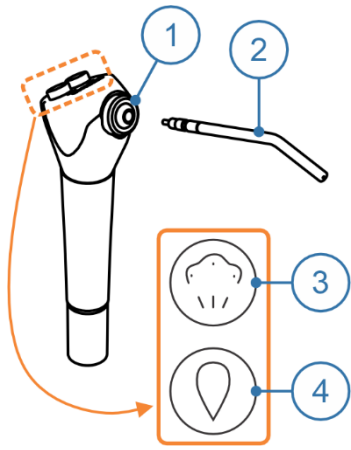

### 7.2. 3-Way Syringe

Before starting the use of the 3-Way Syringe, attach the Syringe Nozzle (2) by pressing the Locking Ring (1) to the correct fitting.

**Air jet:** press the air button (3).

**Water jet:** press the water button (4).

**Spray jet:** press the air (3) and water (4) buttons simultaneously.

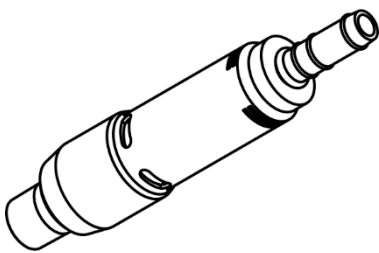

### 7.3. Micromotor

#### 7.3.1. Electric Micromotor

The Olsen electric micromotor requires no cooling and has speed and direction of rotation control.

#### 1. Technical Characteristics:

- Rotation: 0 to 35000 RPM;
- Torque: 2,6 Ncm;
- Power supply: 24 V;
- Max. power: 60 W.

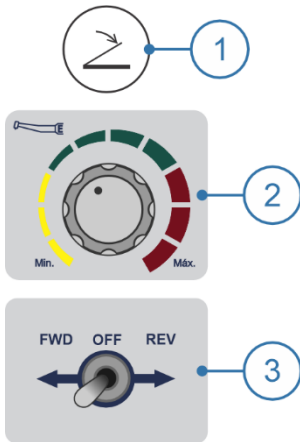

#### 2. Operation:

Before starting operation, connect the handpiece to the Electric Micromotor.

**Activate rotation:** press the Propulsion Button (1) on the foot control.

#### 3. Adjustments:

**Set speed:** Turn the Speed Adjust knob (2) until the desired speed is reached.

**Change rotation direction:** use the rotation direction selector (3).

- FWD: clockwise;
- OFF: off;
- REV: counterclockwise.

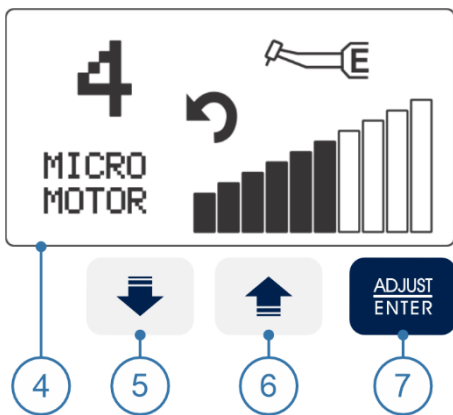

#### 4. Adjustments to the ChronoLub System

When removing the electric micromotor from the holder, the ChronoLub System (4) will identify the micromotor, its position number on the working table (1 to 5), the direction of rotation, and display the speed bar.

**Adjust speed:** Use buttons (5) and (6) to increase or decrease the speed.

**Change rotation direction:** Use button (7) to change the rotation direction.



**To change the direction of rotation, wait for the micromotor to stop turning completely.**

### 7.3.2. Brushless Micromotor - Side Panel

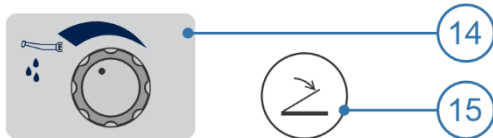
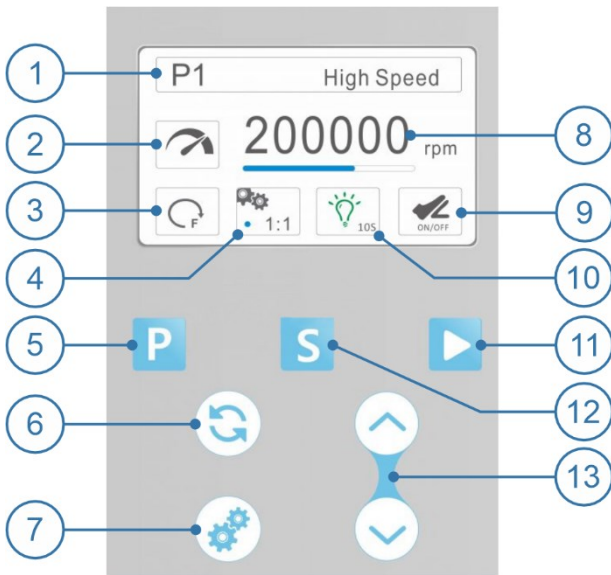

Program	Default settings
P1 My favorite 1	
P2 My favorite 2	
P3 Tooth prep (H)	1:5 / 200.000 rpm
P4 Tooth prep (L)	1:5 / 20.000 rpm
P5 Contra angle	1:1 / 40.000 rpm
P6 Straight	1:1 / 40.000 rpm
P7 Polishing	1:1 / 5.000 rpm

Gear ratio	Speed range (rpm)
1:5	10.000 - 200.000
1:1	2.000 - 40.000
4:1	500 - 10.000
10:1	200 - 4.000
16:1	100 - 2.500
20:1	100 - 2.000

Clockwise	Counterclockwise

LED off	LED on without delay	LED on 10s delay

Speed according to foot control pressure	Runs at the maximum speed

Minimum pressure from 0.03 to 0.10 Mpa	Maximum pressure from 0,20 to 0,40 Mpa

The Brushless Electric Micromotor with Side Panel has LED lighting, spray cooling, and side control panel with LCD screen that indicates the functions used. It enables speed adjustment programming for the following transmissions: 1:5, 1:1, 4:1, 10:1, 16:1, and 20:1. With 7 programming memories, two of which are customizable.

#### 1. Technical characteristics:

- Torque: ~3.5 Ncm;
- Maximum power: 120 W;
- LED: 25000 Lux;
- Rotation speed: from 100 to 200000 RPM.

#### 2. Operation:

Before starting operation, connect the handpiece to the Brushless Micromotor.

**Activate rotation:** press the Propulsion Button (15) or the Manual Start button (11). The On/Off indicator (2) will turn blue.

**Select a preset program:** use the Program button (5). There are 7 programs available, according to the Program Table (A). The selected program is displayed (1).

**Save program:** select program P1 or P2, then select the desired gear ratio and adjust the speed. Press and hold the Program button (5) until the system saves your settings.

**Adjust speed:** use the Adjustment buttons (13) to increase or decrease the speed. The selected speed is displayed (8). See the Speed Table (B) for the speed range for each gear ratio value.

**Select gear ratio:** use the Gear Ratio button (7). The selected gear ratio is displayed (4).

**Change direction of rotation:** use the Directional button (6). The selected direction is displayed (3).

**Adjust water in the micromotor:** use the Water Adjustment knob (14) on the instrument panel.

**Access the Setup menu:** press and hold down the Setting button (12). Use the Setting button (12) again to select the desired option.

**Configure LED options:** from the Setup screen, use the Adjustment buttons (13) to set the desired parameter.

**Set Pneumatic Activation Mode:** within the Setup screen, use the Adjustment buttons (13) to adjust the parameter. The selected activation mode is displayed (9).

**Set Inlet Pneumatic Pressure:** Within the Setup screen, use the Adjustment buttons (13) to adjust the parameter.



**The micromotor system is pre-set by the factory according to the internal pressure of the equipment. It is not recommended to change the pressure parameters.**

7.3.3. Bien Air Micromotor - Side Panel

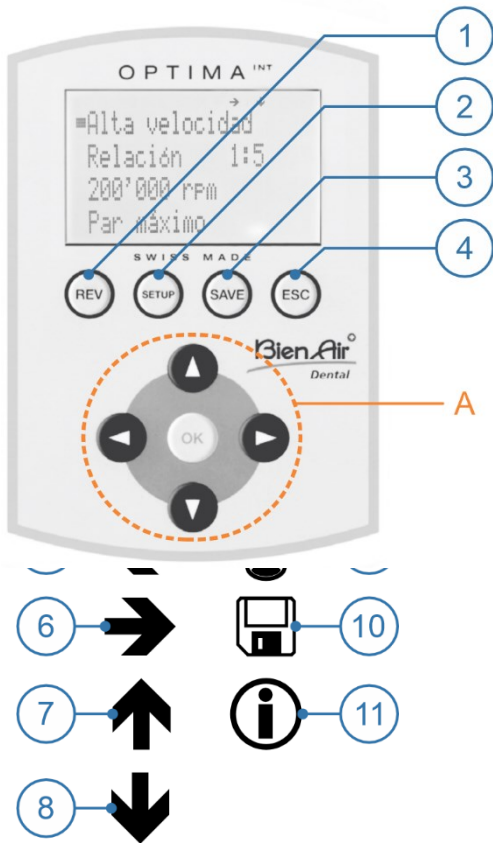

Bien Air's Electric Micromotor with Side Panel has LED lighting, spray cooling, and side control panel with LCD screen that indicates the functions used. It enables programming speed adjustment, rotation direction inversion, light adjustment, preset programs, and 10 customizable programs.

1. Operation:

**Reverse rotation (1):** this function allows reversing the motor rotation direction. It can be selected directly in all programs of the Operative mode. For Endo mode, the settings must be made in SETUP mode. When selected, a sound signal is emitted, indicating the rotation reversal.

**Setup (2):** the SETUP button allows you to enter the Side Panel settings.

**Save changes (3):** there are two ways to save changes to a program: a) Press and hold the SAVE button. The values are stored directly; b) Briefly press the SAVE button. The following options are displayed on the screen:

- Save: the values are saved directly;
- Save as: the values are saved under a new name;
- Rename: Changes the name of a program;
- Delete: deletes a program;
- Program Sorting: changes the order of the programs.

**Back (4):** this button lets you leave the current screen. Use it when you want to cancel changes or go back to the previous screen.

**Navigation and confirmation buttons (A):** use the navigation and confirmation buttons to make the necessary adjustments to your procedure.

**2. Presetting:** during side panel presetting, you can adjust Language, Light, Endo details, Beep Volume, and other advanced settings. Use the navigation and confirmation buttons to make adjustments.

**3. Setup:** on the main screen of the Side Panel you can select the Operative or Endo function. Selecting any of these functions makes available the settings and selection of Program, Gear Ratio, Speed, and Torque.

4. Description of the screen icons:

- 5 - You can scroll to the left using the left button;
- 6 - You can scroll to the right using the right button;
- 7 - You can scroll to the up using the up button;
- 8 - You can scroll to the down using the down button;
- 9 - Hourglass - wait;
- 10 - Floppy disk - memorized value;
- 11 - Info - information or error displayed.

 **Olsen does not supply the cleaning and lubrication spray.**

 **See the manufacturer's manual for more information on operation, cleaning, and maintenance.**

### 7.3.4. Bien Air Micromotor - Instrument Panel

The Bien Air micromotor has speed and rotation direction control.

#### 1. Operation:

Before starting operation, connect the handpiece to the Electric Micromotor.

**Activate rotation:** press the Propulsion Button (1) on the foot control.

#### 2. Button adjustments:

**Set speed:** Turn the Speed Adjust knob (2) until the desired speed is reached.

**Change rotation direction:** use the rotation direction selector (3).

- FWD: clockwise;
- OFF: off;
- REV: counterclockwise.

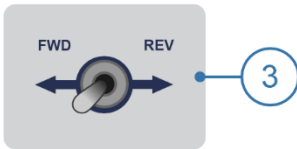
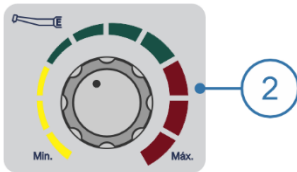
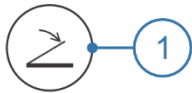

To change the direction of rotation, wait for the micromotor to stop turning completely.



Olsen does not supply the cleaning and lubrication spray.



See the manufacturer's manual for more information on operation, cleaning, and maintenance.

### 7.4. Scaler

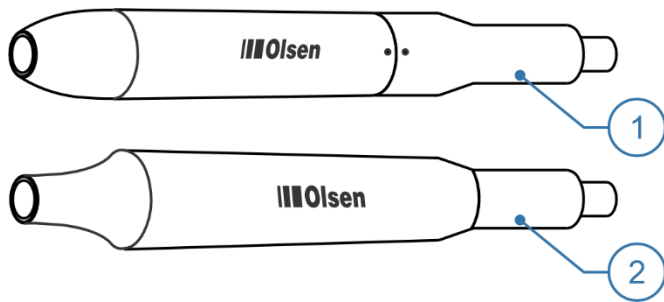

The scaler has an electronic circuit board for ultrasonic generation that, through a piezoelectric system, provides vibration of the tip at high frequency. The vibration power and the cooling water flow can be adjusted through individual controls. There are two models of scaler configuration, with LED (1) and without LED (2).

This instrument is designed for use in dental applications, such as scaling, root planing, root canal treatment, periodontal and cavity preparation.

#### 1. Technical characteristics:

- Frequency: 28 kHz  $\pm$ 3 kHz;
- Power supply: 24 VCA;
- Output force (half-displacement): <2 N;
- Power: 3 to 20 W;
- Operating Mode: Continuous;
- Tip vibration displacement:  $\leq$ 100  $\mu$ m.

#### 2. Precautions for Use:

- Check the vibration outside the patient's oral cavity prior to use. If any abnormality is found, discontinue use immediately and contact Olsen authorized service personnel;
- Wear gloves when handling the scaler or its components;
- Use only the Torque and Endo wrenches for attaching and removing tips. If the tip is not properly secured, it will lose vibration;
- This scaler has been developed for professional dental use only and should not be used for any other purpose; The tip wears out with use, this can cause a reduction of power. If this occurs, replace the tip;
- Do not sharpen or bend the tip. Tips can be damaged and do not generate enough vibration;
- While in use, the scaler system may affect computers and LAN cables. During an operation next to radio device, interference may be heard;
- Use only autoclave proper for dental use to sterilize tips, wrenches, transducer and LED;
- Respect the maximum operating power of the tips used with scaler. The use of power above the recommended will cause damage to the tip and scaler;
- Keep it away from patients with cardiac pacemakers or anesthetized;
- During the scaler use, the tip temperature may rise if the spray is not used. Always use enough spray water for the cooling of the handpiece and the teeth;
- Use the device only on the teeth. Contact with skin, gums and mucous membranes may cause injury;
- Keep the scaler away from explosives and flammable materials;
- Do not submit the handpiece to any strong impact or drop it;
- Do not use it on metal, or ceramic, porcelain or resin prostheses;
- Do not touch and do not wet the back of the transducer, where there are electrical connections to the power cord. This can result in electric shock;
- Do not force the scaler cable when removing it. This may cause disconnection.



**People with pacemakers are forbidden to use or go near the scaler during its use.**



**The use of scaler in hemophilia patients is forbidden.**



**The use of scaler in cardiac patients, pregnant women, or children should be performed with caution.**

# Operating Instructions

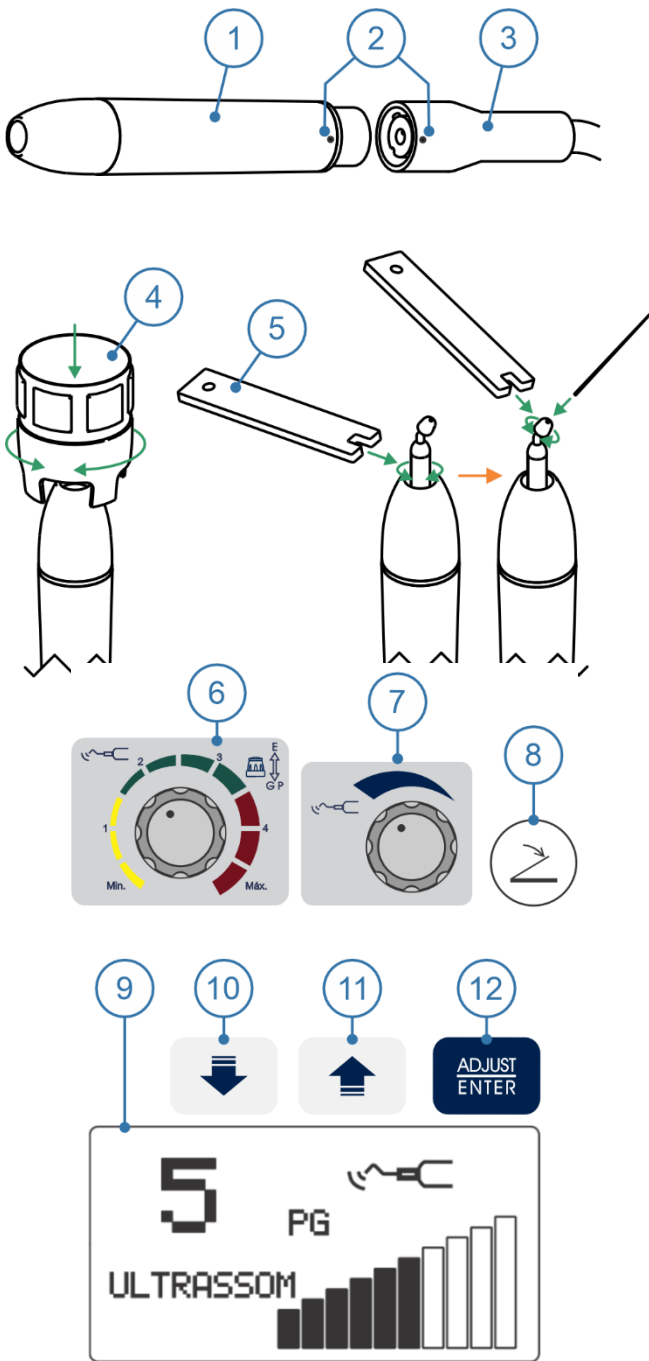

### 3. Operation:

For scaler operation, it is necessary to connect the Transducer (1) to the Coupling (3) and install the scaler tip on the Transducer (1).

**Fitting the transducer to the coupling:** align the points (2) of the two parts and carefully snap them together.

**Installing the scaler tips:** place the Torque Wrench (4) attached to the tip and then turn it clockwise until it is tight. After installing the tip, check for leakage between the Transducer (1) and the Coupling (3). To remove the tip, turn it counterclockwise with the Torque Wrench (4).

**Installing the file adapter** (not supplied with the scaler): fit the adapter to the transducer and screw it gently. Use the Endo Wrench (5) to lock it. Fit the file on the end of the adapter and use the Endo Wrench (5) to tighten it. To remove the adapter, use the Endo Wrench (5) to loosen it, and then carefully unscrew it.

**Activate scaler:** press the Propulsion button (8) on the foot control.

**Adjusting vibration power:** turn the Power Adjust knob (6) until the desired power is reached.

**Water Adjustment:** use the Water Adjustment knob (7) on the instrument panel.

**Toggle functions:** To toggle functions: push the control knob (7) in direction of the table for "GP" function (General-Perio). Pull the knob gently in the opposite direction of the table for "E" (Endo) function.

### 4. Scaler settings in the ChronoLub System:



When removing the scaler from the holder, the ChronoLub System (9) will identify the scaler, the number of its position on the working table (1 to 5), the selected function ("PG" or "E") and show the vibration power bar.

**Adjusting Vibration Power:** use the buttons to decrease (10) or increase (11) the power, which will be indicated by the vibration power bar.

**Toggle functions:** use the button (12) to toggle between the "PG" (Perio-General) and "E" (Endo) functions, indicated in the center of the ChronoLub System (9).



**It is not possible to toggle PG/E functions during scaler operation (propulsion button pressed).**

	Funct.	Power	Use
	PG	1-10	Removal of calculus and plaque in the supragingival region, interdental and tooth surface
	PG	1-10	Removal of subgingival calculus.
	PG	1-6	Removal of deep subgingival calculus.

### 5. Scaler tips:

The tips GD1, PD1 and PD3 are included with the scaler. In the table to the side are available the power and application information for each tip.



**Do not use the tip in any function other than that specified by the manufacturer.**



**When using tips with a power limit below 100%, respect the operating power indicated by the manufacturer. Using more power than recommended will cause damage to the tip and the scaler.**

## 7.5. Saliva Ejector

As an option, the Quick Coupling system can be applied to the Venturi and Vortex ejector hose, making it easier to remove the device for cleaning.

The Adapters (**A**) allow the coupling of cannulas of Ø 6.3, 9.5 and 11 mm. Before starting the operation, snap the cannula onto the Adapter. The Adapters are removable, facilitating replacement and cleaning.

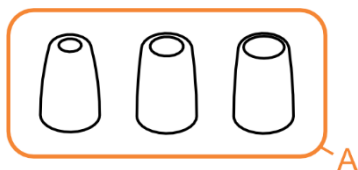

### Force required to insert/remove the cannula

Cannula	Insert	Remove
Ø 6,3 mm	1 a 2,2 kgf	0,4 a 1,7 kgf
Ø 9,5 mm	0,9 a 1,8 kgf	0,3 a 1,2 kgf
Ø 11 mm	0,7 a 1,2 kgf	0,2 a 0,5 kgf

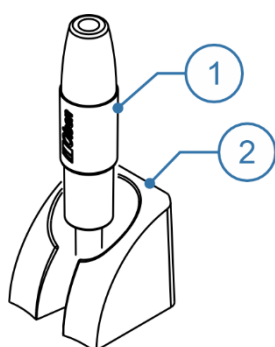

### 7.5.1. Venturi Ejector

Compatible with cannula adaptor Ø 6.3 and 9.5 mm.

The Venturi instrument (**1**) uses the compressed air from the compressor to generate suction.

**Activate/Deactivate suction:** remove the ejector from its holder (**2**) to activate, or put it back on to deactivate.

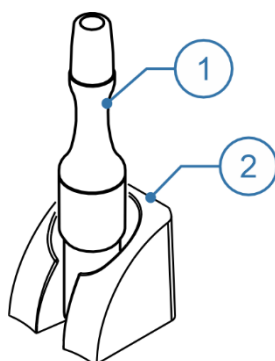

### 7.5.2. Vortex Ejector

Compatible with cannula adaptor Ø 6.3 and 9.5 mm.

It uses the Venturi system for suction, but its capacity in volume is higher, reaching up to 385 mm/Hg. The Vortex ejector (**1**) can be used for suction in small surgical and prophylaxis procedures.

**Activate/Deactivate suction:** remove the ejector from its holder (**2**) to activate, or put it back on to deactivate.

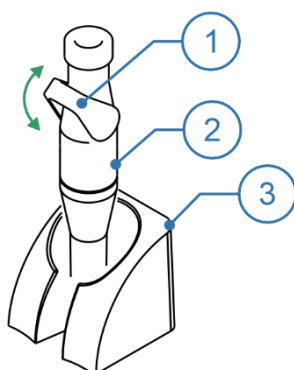

### 7.5.3. Vacuum Pump Ejector

Compatible with cannula Ø 11 mm.

It makes it possible to use a vacuum pump as suction in the assistant module or water unit. The holder of this ejector is equipped with a device for automatic ignition and shutdown of the pump. Moreover, the ejector have suction flow control.

**Activate/Deactivate suction:** remove the ejector (**2**) from its holder (**3**) to activate, or put it back on to deactivate.

**Adjust suction flow:** to decrease or increase the suction flow, move the handle (**1**) closer to or farther away from the sucker.

## 7.6. Curing Light

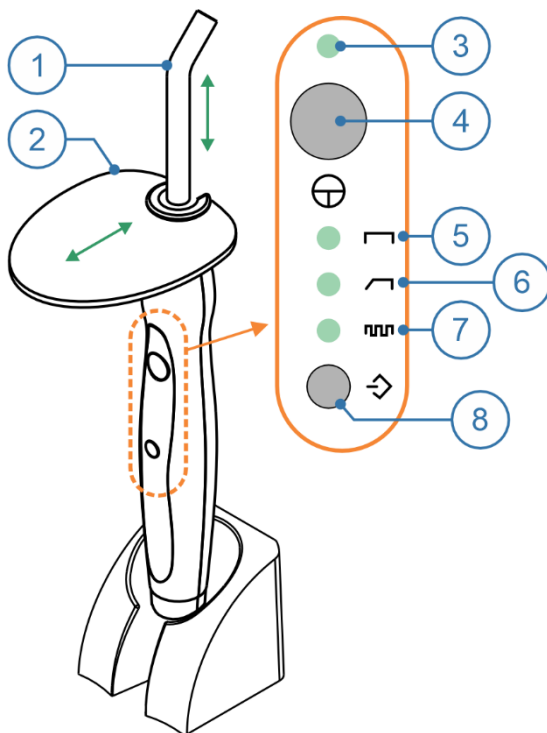

A device for polymerization of restorative and tooth whitening materials, the curing light produces light radiation to solidify light-sensitive resins with a short-time firing duration.

### 7.6.1. Olsen Curing Light

This instrument features a 20 s timer for continuous use and a protection mode to prevent overheating. If the curing light is operated several times consecutively without a break, the protection mode will be activated, locking the device for 20 s after each operation. To disable the protect mode, leave the device idle for 4 minutes. The protective mode can be automatically activated after 9 consecutive activations.

#### 1. Technical characteristics:

- Dimensions: 26 x 25 x 260 mm;
- Wavelength: 420-480 nm;
- Net weight: 135 g;
- Operation: continuous, ramp, and pulse;
- Light intensity: 1000-1200 mW/cm<sup>2</sup> (with fiber optic tip).

#### 2. Audible warnings:

- Triggering the mode selection button;
- On/Off button actuation;
- After 10 seconds of operation;
- After 20 seconds of operation.

#### 3. Precautions for use:

- Prohibited for use in patients with biological light sensitivity reactions;
- Do not aim the light from the curing light directly into the eyes. The curing light produces optical radiation emitted by LED;
- Do not touch the tip directly to polymerizable material. This will prevent material from sticking to the tip, impairing the performance of the device;
- Do not use the curing light without the Shield (2);
- The curing light tip should only be used on teeth. Avoid touching the patient's gums, lips or skin;
- Use the curing light only on the dental plane;
- After 40 seconds of continuous operation, the tip end can reach 56° C;
- Consecutive activations of the curing light may cause the tip to heat up to a maximum temperature of 68° C.



**The use of the curing light unit in cardiac patients, pregnant women or children should be carried out with caution.**

#### 4. Operation:

Before starting the operation of the curing light, install the Tip (1) and the Shield (2).

**Installing the tip:** first snap the shield (2) onto the tip (1) and then snap the tip into the curing light body. The Tip (1) should be pushed all the way into the curing light assembly.

**Enable/Disable the curing light:** press the On/Off button (4) 2 times. The Power LED (3) will light up and the curing light will run for 20 seconds and automatically switch off.

**Toggle operation mode:** each press of the select button (8) toggles the operation mode. Press the button (8) until the LED indicates the desired mode.

#### Operation Modes:

- **Continuous (5):** turns on at full power for 20 seconds;
- **Ramp (6):** turns on at minimum power, increasing progressively. In 5 seconds it reaches maximum power, keeping it until the 20-second cycle ends;
- **Pulse (7):** device flashes for 20 seconds.

### 7.6.2. Valo Curing Light

The VALO is an LED curing light device for polymerizing light-curing materials in the wavelength range of 395-480 nm.

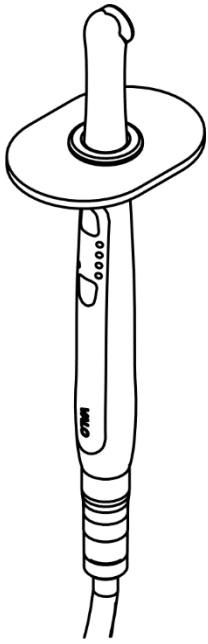

**1. Precautions for use:**

- Do not look directly at the light output. Patients, clinical staff and assistants should always wear UV eye protection during use;
- Proceed with caution when treating patients suffering from adverse photobiological reactions or sensitivity, patients undergoing chemotherapy treatments, or patients being treated with photosensitizing medication;
- Do not expose oral soft tissue at close range for more than 10 seconds in any mode. If a longer polymerization time is required, use several shorter polymerization cycles to avoid heating of the soft tissue or use a dual-curing product;
- If using the VALO too close to the gingiva, do not expose tissue for more than 20 seconds. If 40 second polymerization is required, allow 10 seconds between two 20 second polymerizations. If longer polymerization time is required, consider using a dual-curing product;
- The Xtra power mode has a 2 second safety delay to limit heating during consecutive polymerization. At the end of the delay, the sound signal indicates that the unit is ready to continue use;
- Proceed with extra care to avoid directing the light into soft tissue.

**3. Operation:**

**Sleep Mode:** the instrument will go into sleep mode after 1 hour of inactivity, indicated by the green, the green Indicator will blink slowly. Press any button to activate the instrument at the last used setting.

**Operation modes, light indicators, and time:**

Mode Power Level	Standard Power 1000 mW/cm <sup>2</sup>				High Power 1400 mW/cm <sup>2</sup>				Xtra Power 3200 mW/cm <sup>2</sup>	
Power Button										
Mode/Timing LEDs										
Time Button Time Options										
To Change Time	Press and release Time Button quickly to cycle through time options.									
To Change Modes	Press and hold the Time Button for 2 seconds and release. VALO will cycle to next Mode.									
Legend	Solid LEDs				Blinking LEDs					

**Polymerization time:**

Exposure times may need to be adjusted due to the reactivity of the composite, the shade, the distance from the light lens to the composite, and the depth of the composite layer if greater than 2 mm.

Mode	Standard Mode	High Power Mode	Xtra Power Mode
Power Level	1000 mW/cm <sup>2</sup>	1400 mW/cm <sup>2</sup>	3200 mW/cm <sup>2</sup>
Per Layer	One 10 second cure	Two 4 second cures	One 3 second cure
Final Cure	One 20 second cure	Three 4 second cures	Two 3 second cures

## 7.7. Prophylaxis System

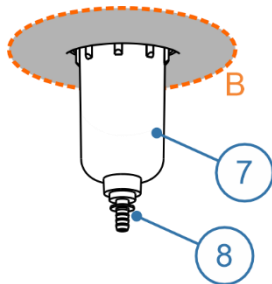
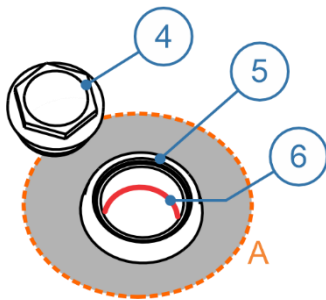
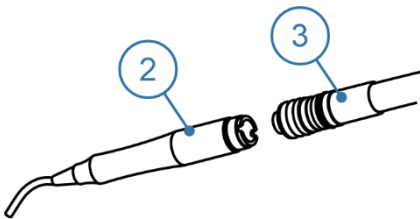
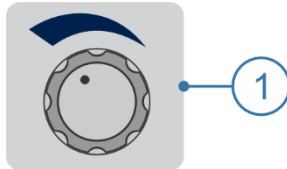
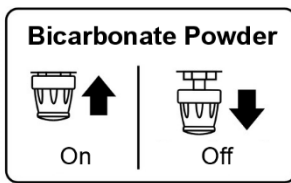

### 1. Precautions for use:

- Do not fill the bicarbonate reservoirs with more than the indicated amount. Excessive amounts of bicarbonate may impair the operation and performance of the device;
- After using the instrument, pull the valve (1) to shut off the bicarbonate flow. Then, point the instrument toward the bowl, keeping a distance of 15 cm, and press the foot pedal (9) for approximately 10 seconds. The compressed air will remove powder buildup, extending the service life of the equipment
- When handling the sodium bicarbonate or using the bicarbonate jet, keep the environment ventilated and avoid inhaling the dust. In case of inhalation, move to a ventilated area;
- To reduce the risk of inhalation of the bicarbonate mist, use a Venturi or Vortex suction tube while using the bicarbonate jet;
- Use only sodium bicarbonate specific for dental use, available at any specialized dental supply store.

### 7.7.1. Bicarbonate Jet

Prophylaxis device system through the application of bicarbonate jet. Besides the handpiece (2) it has a bicarbonate reservoir (5), located in the upper part of the assistant module (A), and a humidity filter (7) with drain (8), located in the lower part (B).

The bicarbonate reservoir has a line (6) on the inside that determines the limit for filling with sodium bicarbonate.

#### 1. Operation:

Before starting to use the bicarbonate jet, it is necessary to fill the reservoir (5) with sodium bicarbonate, check the humidity in the filter (6), and connect the bicarbonate jet handpiece (2) to its coupling (3).

At the end of each procedure, clean the reservoir (5).

**Fill the bicarbonate reservoir:** open the reservoir (5) by turning the cap (4) counterclockwise and deposit the sodium bicarbonate until the red line (6). Close the reservoir.

**Remove the condensed water in the filter:** press the valve (8) at the bottom of the filter (7) to drain off the water.

**Activate/Deactivate:** press the propulsion pedal (9). The more pressure on the foot control, the greater the volume of the jet emitted by the handpiece. Until the pressure limits of the equipment are reached.

**Adjust spray:** refer to the instructions for use, contained in this document, for the Pneumatic Coupling.

## 8. OPERATING INSTRUCTIONS FOR THE ACCESSORIES

### 8.1. Anti-Stress System

System developed to provide greater comfort to patients. It consists of four massagers positioned inside the upholstery to act on the lumbar region and thighs.

Activated via remote control, these massagers enhance the patient's well-being during dental procedures.

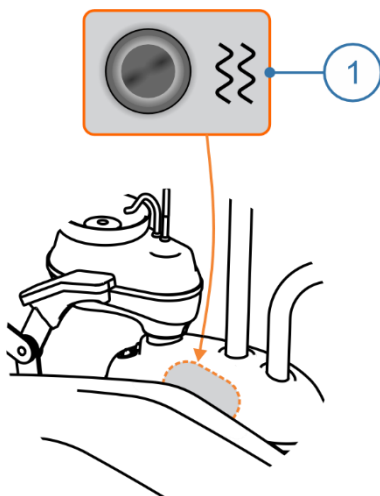

**Activate and Select Intensity:** press and hold the On/Off button (1). At each stage, an audible beep is emitted at approximately one-second intervals, indicating the intensity level:

- One beep: light vibration.
- Two beeps: medium vibration.
- Three beeps: strong vibration.

Release the button after hearing the beep corresponding to the desired intensity to start operation.

**Turn Off:** press the On/Off button (1) again briefly, without holding it down.

**Automatic Shutoff:** the system will automatically turn off after 15 minutes of operation. A 10-minute off period must be observed to prevent overheating.

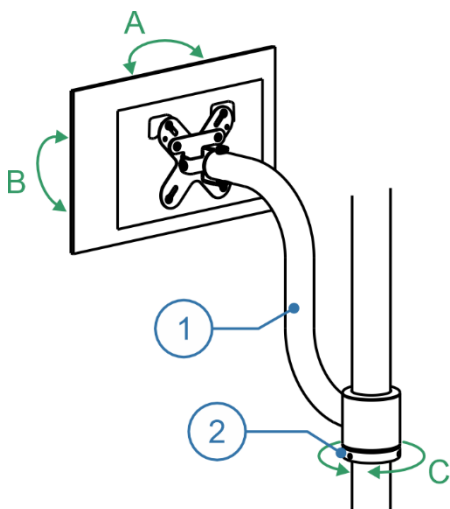

### 8.2. Monitor Support

The Monitor Support (1) attaches to the dental light support arm column and is held in place with the attachment ring (2) secured with a 3mm Allen screw. Supports monitors from 14" to 19".

The stand features on-axis swivel (C), tilt adjustment (B) and side swivel (A) for the monitor.

The monitor is sold separately and is not part of this device.

**Precautions for use:**

- Do not install any device with a power supply higher than 24 V on the monitor support;
- Maximum weight on the support is 1 kg.



### 8.3. Thermo Comfort

System that provides warm water to all instruments that use water, with an output temperature between 35°C and 45°C. Depending on the model, it may feature temperature control. Its function is to enhance patient comfort by minimizing temperature sensitivity during dental procedures.

**Enable/Disable:** press the Thermo Comfort On/Off button (1).

**Technical characteristics:**

- Bleeding time: ~6 seconds;
- Maximum temperature in the syringe: 45° C;
- Reservoir capacity: 100 mL;
- Time for initial warm-up: ~14 min.



### 8.4. Air Jet System

The Air Jet system provides agility in the procedures with high rotation turbine. It consists of the release of a continuous air jet by the turbine itself, eliminating the use of the syringe for this function. Activated by a command on the working table.

**Enable/Disable:** press the Air Jet On/Off button (2) on the control panel. When Air Jet is on, continuous air jet starts as soon as the handpiece is removed from the holder. When you press the propulsion button (3), the air jet stops, and the handpiece operates normally. When you release the propulsion button (3), the air jet restarts until the Air Jet system is turned off or the handpiece is placed in its holder.



### 8.5. X-Ray Viewer

With LED backlight display, it allows the viewing of radiographs without moving away from the patient.

**Enable/Disable:** press the X-Ray Viewer On/Off button (4).

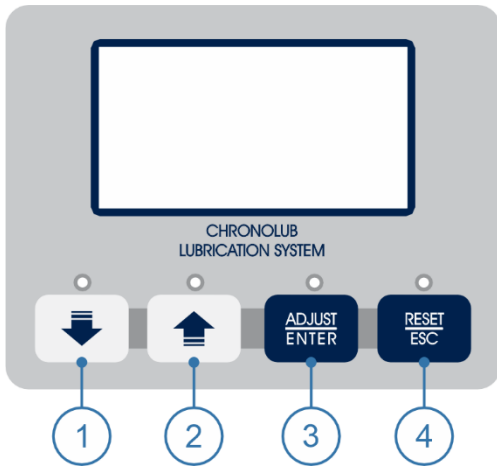

## 8.6. ChronoLub System

This system features the ChronoLub function, which is an electronic timer used to monitor the usage time of the equipment's rotating instruments and indicate the correct moment for lubrication, through a message on the panel and audible warning. The ChronoLub System also makes available the digital adjustment of optional devices such as the Scaler and the Electric Micromotor, Date and Time information, Birthday reminder, temperature adjustment of the Thermo Comfort system, Software Version and Cardiac Monitor.

- 1 - Decrease;
- 2 - Increase;
- 3 - Adjust/Enter;
- 4 - Reset/Esc.

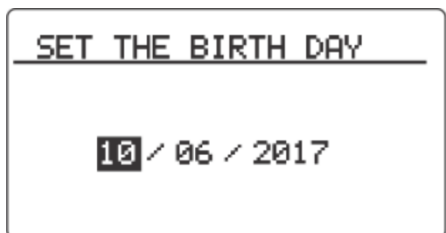
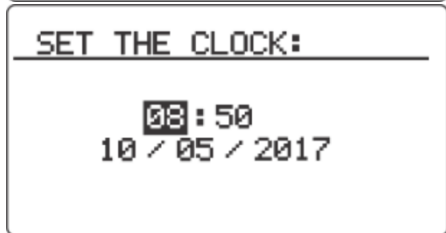
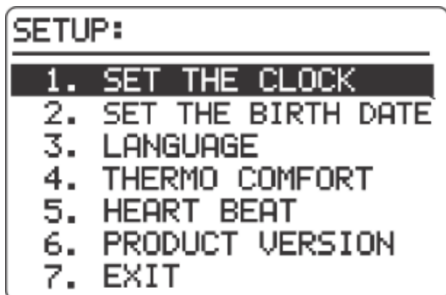
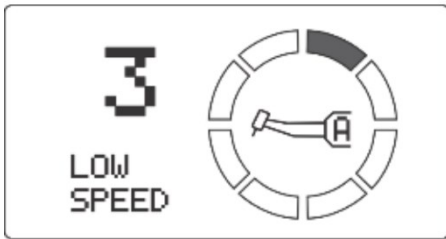
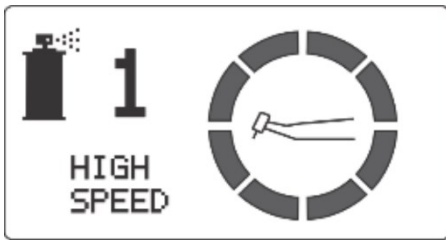

### 8.6.1. ChronoLub

When removing the hand piece from the holder, the ChronoLub System will identify whether the coupling is for low or high rotation, show its position number on the working table, and a segmented circle representing the time the handpiece can be used. When the last segment starts blinking, it means that the handpiece can be used for another 2 minutes.

When the usage time runs out, it beeps three times and displays a spray can on the screen. From this moment on, whenever the handpiece is removed from the holder, the system will beep, repeating the warning every 2 minutes while the handpiece is in use or out of the holder.

After lubricating the handpiece, with it out of the holder, press the Reset/Esc button (4) for 3 seconds to restart the time counting. This procedure can be done at any time.

### 8.6.2. Clock - Date and Time

**Access Clock function:** press the Adjust/Enter button (3) for 3 seconds to access the SETUP screen. Use the adjust buttons (1 and 2) to select the option 1. SET THE CLOCK.

**Adjust Date/Time:** press the Adjust/Enter button (3) to access the ADJUST CLOCK screen. Use the adjust buttons (1 and 2) to change the selected value. Use the Adjust/Enter button (3) to toggle the selection.

**Save the changes:** press the Adjust/Enter button (3) for 3 seconds.

**Return to the main menu or cancel:** press the Reset/Esc button (4).

### 8.6.3. Birthday

**Access Birthday function:** press the Adjust/Enter button (3) for 3 seconds to access the SETUP screen. Use the adjust buttons (1 and 2) to select the option 2. SET THE BIRTH DATE.

**Adjust Birth Date:** press the Adjust/Enter button (3) to enter the ADJUST ANNIVERSARY screen. Use the adjust buttons (1 and 2) to change the selected value. Use the Adjust/Enter button (3) to toggle the selection.

**Save the changes:** press the Adjust/Enter button (3) for 3 seconds.

**Return to the main menu or cancel:** press the Reset/Esc button (4).

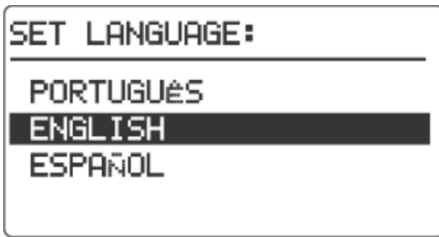

### 8.6.4. Language

**Access language function:** press the Adjust/Enter button (3) for 3 seconds to access the SETUP screen. Use the adjust buttons (1 and 2) to select the option 3. LANGUAGE.

**Change language:** press the Adjust/Enter button (3) to access the SET LANGUAGE screen. Use the adjust buttons (1 and 2) to select the desired language.

**Save the changes:** press the Adjust/Enter button (3) for 3 seconds.

**Return to the main menu or cancel:** press the Reset/Esc button (4).



### 8.6.5. Thermo Comfort

**Enable/Disable:** press the Thermo Comfort On/Off button (5) on the control panel.

**Adjust water temperature:** press the Adjust/Enter button (3) for 3 seconds to enter the SETUP screen. Use the adjustment buttons (1 and 2) to select option 4. THERMO COMFORT. Press the Adjust/Enter button (3) to enter the TEMPERATURE SETTING screen. Use the adjustment buttons (1 and 2) to change the temperature.

**Save the changes:** press the Adjust/Enter button (3) for 3 seconds.

**Return to the main menu or cancel:** press the Reset/Esc button (4).



### 8.6.6. Cardiac Monitor

The heart monitor is a supplementary device for monitoring the patient's heart rate. The reading from this device must be considered as an indicator only.

**Activate heart monitor:** identify the input connection (6), located on the side of the table and marked by the icon (5), and insert the plug (7). Attach the sensor (8) to either fingertip of the patient's hand. The patient's heart monitoring will automatically appear after 8 seconds in the lower left corner of the display.

**View only the heart monitor:** press the Adjust/Enter button (3) for 3 seconds to access the SETUP screen. Use the adjustment buttons (1 and 2) to select option 5. HEART BEAT and press the Adjust/Enter button (3).

**Back to the main menu:** press the Reset/Esc button (4).

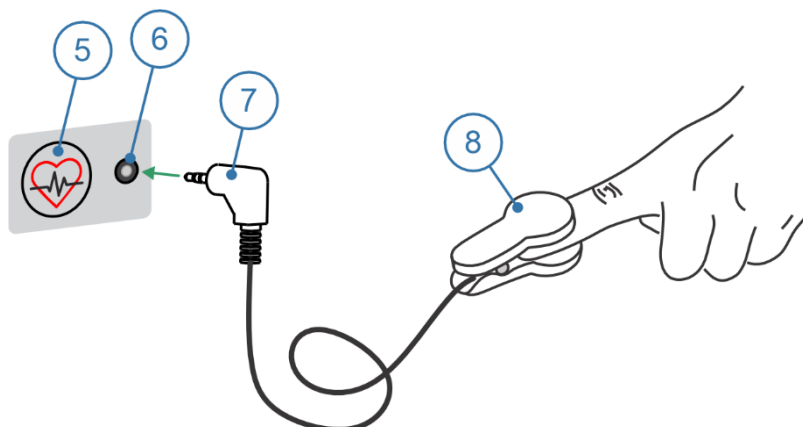
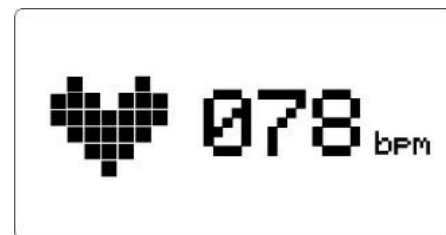

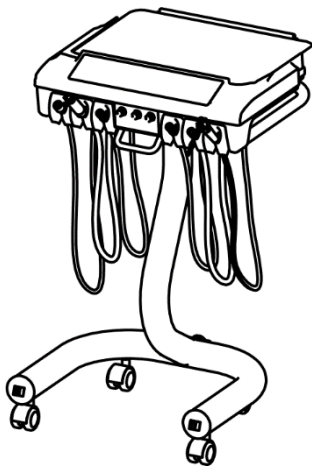

### 8.7. Kart System

The Kart system does not require the use of a support arm, and provides handpieces and working table on a steel base with casters, which provides mobility to the professional.

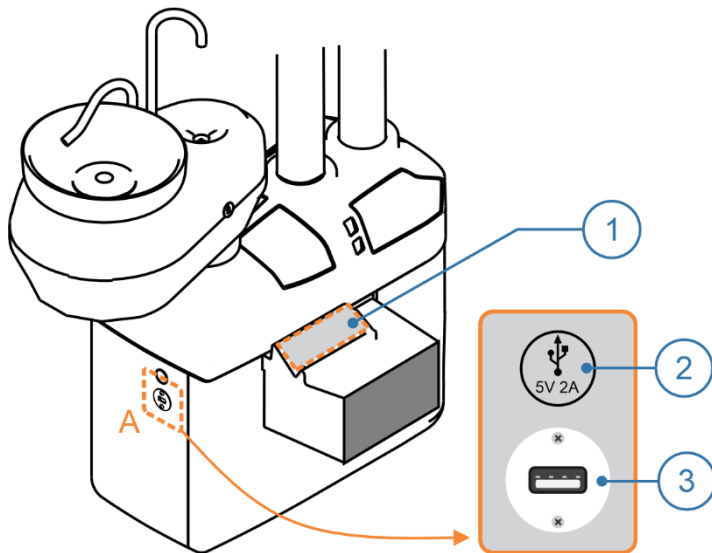

### 8.8. USB Charger

The USB connector (3) is located on the equipment (A) and is identified by the symbol (2). Next to the seat is the cell phone holder (1).

This system provides 5V voltage and a maximum current of 2A.

## 9. CLEANING AND DISINFECTION



Turn off the equipment before starting cleaning and disinfection.



The entire sanitization process must be carried out using gloves suitable for protection, in addition to a mask and goggles, according to biosafety standards.



Cleaning and disinfection must be performed before each patient and at the end of the workday.



The purging process of the water and air lines must be performed for at least 30 seconds for each pneumatic coupling used during treatment.



Never use steel wool or sponges and/or abrasive products, so as not to damage the equipment's components.

### 9.1. Technical Barrier

Whenever possible, use disposable barriers and exchange them between patients. The barrier technique will ensure maximum long-term durability of the equipment surfaces and finishes.

### 9.2. Non-Removable Components

Plastic parts and painted parts should be cleaned with a damp cloth containing only neutral detergent, such as Prolystica® 2X Concentrated neutral detergent (STERIS CORPORATION), diluted according to the manufacturer's instructions until all visible dirt is removed.

Disinfection can be performed with a clean cloth soaked in 0.52% hydrogen peroxide, such as OXIVIR TB EPA Reg. No. 70627-56.

### 9.3. Removable Components

- Always use distilled water for this procedure;
- If the water is heated, to facilitate this cleaning step, the temperature should be between 30° C and 40° C;
- Always use brushes with natural or nylon bristles;
- Use a neutral detergent, such as Prolystica® 2X Concentrate neutral detergent. Dilution should be done as recommended by the manufacturer;
- Do not pile components on top of each other in large numbers to avoid deformation of smaller and delicate parts and to avoid scratching polished surfaces. Handle only one part at a time.

Follow the steps in the table below as indicated:

Components of the water unit, the headrest unit, the heart monitor connector, the electric micromotor, the bicarbonate jet handpiece, the removable Prophy-Jet tip and the dental light polycarbonate protection.	Other removable components
<p>a) Apply the solution with a soft sponge or cloth covering the entire surface, keeping the solution in contact with the component for at least 3 minutes;</p> <p>b) Scrub the entire external and internal surface of each component using a sponge or soft brush, making circular movements. Repeat this procedure until all visible dirt is removed, making sure that all recesses are washed;</p> <p>c) Use a cloth or sponge soaked with water to remove all detergent from the surface.</p> <p>d) Spray the entire surface of the component with a 0.52% hydrogen peroxide solution such as OXIVIR TB and leave it for 5 minutes;</p> <p>e) Use a cloth or sponge soaked with water to remove all detergent from the surface;</p> <p>f) Dry the component with a soft, clean cloth.</p>	<p>a) Soak the entire component in detergent solution, keeping the solution in contact with the component for at least 3 minutes;</p> <p>b) Scrub the entire external and internal surface of each component using a sponge or soft brush, making circular movements. Repeat this procedure until all visible dirt is removed, making sure that all recesses are washed;</p> <p>c) Rinse the component under running water for at least 1 minute;</p> <p>d) Spray the entire surface of the component with a 0.52% hydrogen peroxide solution such as OXIVIR TB and leave it for 5 minutes;</p> <p>e) Rinse the component under running water for at least 1 minute;</p> <p>f) Dry the component with a soft, clean cloth.</p>

### 9.4. Autoclave Sterilization



**Do not use any type of oil on the items to perform the autoclave.**



**The scaler transducer with LED and the brushless micromotor cannot be autoclaved in contact with other materials.**

• Items that can be sterilized in autoclave:

- Transducer with scaler LED;
- Scaler tips and wrenches;
- 3-way syringe tip;
- Prophy-Jet, bicarbonate jet handpiece and removable tip;
- Micromotor brushless.

a) Before autoclaving, sanitize the items, removing all organic residues from the surface and internal ducts (if any). Then carefully dry each item, including the internal ducts, if possible using compressed air.

b) Individually pack each item, with sterile packaging suitable for the autoclaving process.

• For sterilization use a steam autoclave:

- 3-Way Syringe tip: 132° C, 4 minutes;
- Transducer with scaler LED, scaler tips and wrenches: 132° C, 4 minutes;
- Micromotor: 121°C, 15 minutes.

• The service life of the instruments and accessories mentioned is determined by wear and damage due to use or mechanical damage.

c) After performing the sterilization process, evaluate the parts for the occurrence of wear on the tip or mechanical damage. In these occurrences, the parts should be discarded.

### 9.5. Water Tanks and Water Hoses

For the cleaning and disinfection of water tanks and hoses, the use of a 0.78% silver-based disinfectant is recommended. To perform the cleaning, follow the instructions indicated by the product manufacturer.



**Use the disinfectant according to the manufacturer's instructions.**

### 9.6. Internal Suction Hose Cleaning

For internal cleaning of suction hoses for Venturi, Vortex, and Vacuum Pump suction hoses, use a suitable product with descaling action. The cleaning must be performed according to the product's instructions for use.



**Use the disinfectant according to the manufacturer's instructions.**

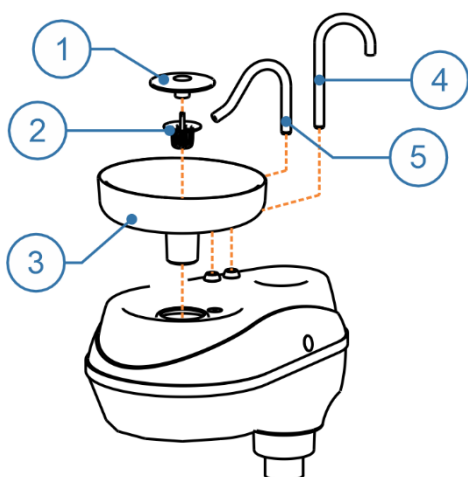
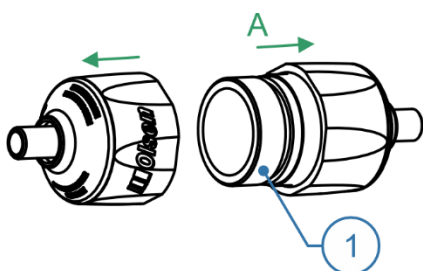
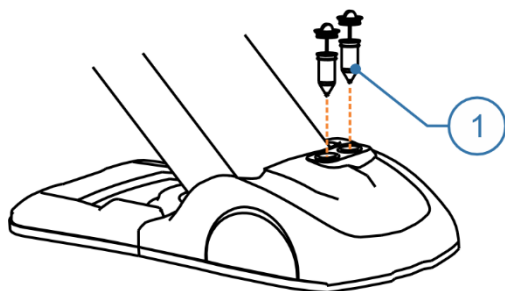

### 9.7. Filters

The debris separator filters should be cleaned daily. Suction efficiency may be impaired if this filter is clogged. In case of reduced suction efficiency, clean the filters.

#### Base filter cleaning:

Remove the filter by pulling the cap (1) and proceed according to the instructions in the Cleaning and Disinfection - Removable Components section.

#### Cleaning the hose filter:

- Detach the filter caps (A);
- Remove the filter body (1) and proceed as per the section Cleaning and Disinfection - Removable Components;
- After cleaning, reassemble.

### 9.8. Water Unit

To remove the bowl (3) for cleaning, remove the drain cover (1), the drain (2), and the detachable ducts (4 and 5), and then remove the bowl (3).

Use tweezers or gloves for drain removal (2) to avoid contact with debris. For cleaning and disinfection, proceed as instructed in the section Cleaning and Disinfection - Removable Components.

### 9.9. Curing Light

For cleaning and disinfection of the curing light tips, use gauze or disposable tissue dampened in water and soap or mild detergent. Do not use alcohol, strong alkaline or abrasive detergents, bleach or acetone based detergents or other germicides.

The acrylic tip is not autoclavable.

Cleaning the curing light should be done with neutral detergent or 70% alcohol.



**Olsen is not responsible for defects, deformities, stains, or changes caused by improper use of chemicals, contact with fabrics, leather, disposable gloves, paints, pigmented detergents, and other organic or synthetic products.**

### 9.10. Valo Curing Light

For cleaning and disinfection of the Valo curing light, follow the instructions in the manufacturer's manual.

### 9.11. Scaler



For both scaler models the following sterilization methods are prohibited:

- Place in boiling water;
- Heat in stove, oven, or microwave;
- Soak in disinfectant such as iodine, alcohol or glutaraldehyde;

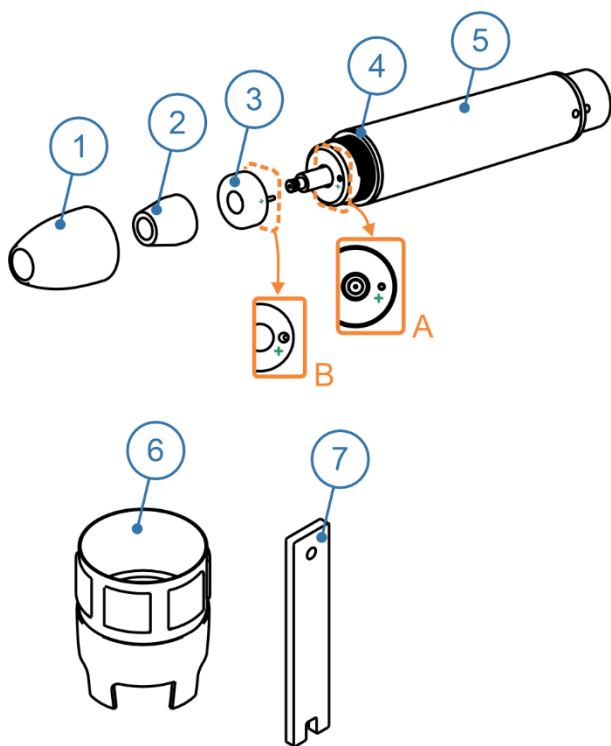

#### 9.11.1. Scaler with LED

The scaler transducer (5), LED (3), tips and wrenches (6 and 7) must be autoclaved.

Before sterilizing these items, remove the scaler tip, cover (1), light guide (2) and finishing ring (4). Clean these items by removing visible dirt with a soft sponge or cloth and running water. For cleaning in the ultrasonic cleaner, use appropriate pure water and a minimum time of 2 minutes and maximum of 10 minutes.

For disinfection, use a 75% alcohol or 2% glutaraldehyde solution to disinfect the tips. Dry the tips at the end of the procedure with a hot air blower.

For the correct operation of the scaler, the LED (3) must be correctly fitted to the transducer (5), matching the positive pole of the LED (B) with the transducer (A).

Use only autoclaves for dental use to sterilize the tips, wrenches, transducer, and LED.

#### 9.11.2. Scaler without LED

The transducer (10) and the scaler tips and wrenches (6 and 7) must be autoclaved.

Before sterilizing these items, remove the scaler tip, cover (8) and finishing ring (9). Clean these items by removing visible dirt with a soft sponge or cloth and running water. For cleaning in the ultrasonic cleaner, use appropriate pure water and a minimum time of 2 minutes and maximum of 10 minutes.

For disinfection, use a 75% alcohol or 2% glutaraldehyde solution to disinfect the tips. Dry the tips at the end of the procedure with a hot air blower.

Use only autoclaves for dental use to sterilize the tips, wrenches and transducer.

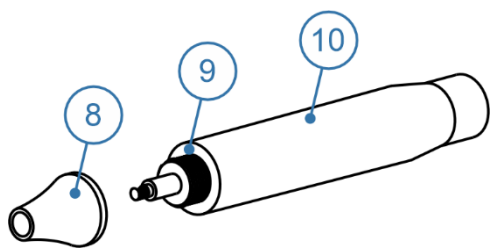

### 9.12. Daily Procedure to Finalize the Working Day

At the end of the working day, observe the following instructions:

- Provide the equipment cleaning by cleaning the ejectors and their hoses, the water unit, the upholstery and if necessary clean the operating light screen, the plastic covers, and metal parts;
- Remove the handpieces that were used during the day (high and low-speed) and provide their lubrication. After the lubrication, sterilize them;
- Remove the other handpieces used during the day: prophylaxis handpiece, 3-way syringe tip, the transducer, and its tips, curing light tips and provide the sterilization of each one;
- Turn off the compressor circuit breaker and open the air reservoir drain;
- Depressurize tanks, remove water and clean filters;
- Remove the bicarbonate of the prophylaxis reservoir;
- Close the water and compressed air main valves that supply the equipment;
- Run the Zero Position command and turn the equipment On/Off switch Off;
- Organic waste, contaminated and disposable materials, must be disposed of properly as determined by the responsible local health agency;
- Follow the instructions in the Cleaning and Disinfection section of this document to correctly clean the equipment and its parts.

### 10. INSTALLATION

It consists of assembling the equipment and installing its supply connections such as water, compressed air, sewage (drain and vacuum when available), and electric power, adjusting the equipment's voltage when necessary.

When assembling the equipment, the technician must level the equipment in relation to the chair, working table and assistant module (when available in the equipment). He must also adjust the pressure of the couplings for the pneumatic turbines, adjust the water and air pressure of the 3-way syringe and spray of the pneumatic instruments, among other activities.

The equipment installation should be performed by an Olsen authorized technician, who should register it in this document. The technician will inspect the equipment, verifying if it maintains its integrity after being transported before use, finalizing the process with the completion of the Check List for extended warranty and orientation as to how to operate, clean and conserve the equipment.

We recommend that the owner of the equipment accompany the technician to perform this Check List so that, if necessary, he can provide the necessary items to ensure the correct installation of the equipment.

#### 10.1. General Installation Considerations



**Only an authorized Olsen Service Technician can unpack and install the product.**



**To access the Olsen Accredited Technical Assistance for installation and maintenance, access our site [www.olsen.odo.br](http://www.olsen.odo.br) contact us by phone +55 48 2106 6000.**



**Installation or maintenance performed by personnel not authorized by Olsen will result in loss of product warranty.**



**This equipment is not designed to be installed or operated in an operating room.**



**Equipment not suitable for use in the presence of a flammable mixture with air, oxygen or nitrous oxide.**



**Equipment not suitable for use in an oxygen-rich environment.**

#### 10.2. Pre-installation

Pre-installation is the preparation of the environment for installation of the equipment. This step should be guided by Olsen authorized service personnel to ensure that the installation environment is adequate to receive the new dental equipment. At this stage, all water, compressed air, drainage and power supply piping should be prepared, providing for the final positioning of the equipment and its accessories.

#### 10.3. Equipment Positioning

The positioning of the equipment and its power connections must conform to the measurements in the Installation Template, supplied by Olsen in digital format with the order confirmation for your equipment.

#### 10.4. Compressed Air

The recommended dental compressor should be oil-free, with dynamic pressure between 5.5 to 7.0 bar (80 to 100PSI), displacement of 150 l/min, and a reservoir of 30 l.

It is recommended to use a filter at the inlet of the equipment to avoid the entrance of humidity, particles and other contaminants, which can not only cause problems in the pneumatic system of the equipment, but also harm the procedures and the patient.

### 10.5. Compressed Air Piping

The use of specific hose for compressed air is recommended, as indicated below:

- Up to 10 m: use 1/4" hose;
- From 10 to 20 m: use 5/16" hose;

Do not use hoses for installations where the distance of the connection piping between the compressor and the equipment is more than 20 meters. In these cases, it is recommended that a specialist be consulted for the correct sizing of the compressor and the type of piping to be used.

The compressed air damper must be easily accessible and located near the equipment.

### 10.6. Water for the Water Unit

The water network must have the following characteristics:

- Working pressure: 2.8 to 4.0 bar;
- Flow limits: > 5 L/min;
- Water hardness: < 2.14 mmol/L (<12° dH);
- Water quality: the water entering the system must be potable, according to local regulations.
- pH limit: 6.5 to 8.5;
- Maximum particle size: < 100 µm;

The water network must have an easily accessible register close to the equipment. For cases of low water pressure, it is recommended that a professional be consulted to evaluate the hydraulic network.

### 10.7. Particle Filters

This equipment is supplied with water and air filters for internal system protection.

We strongly recommend installing filters on the water and air inlets for the protection of the entire system.

#### Recommended filters:

- Water Filter: 100 µm;
- Air Filter: 50 µm.

#### Specifications of the internal filters supplied:

- Water filter: 65 µm;
- Air Filter: 40 µm.

### 10.8. Water to the Reservoir

The water used in the reservoir must be filtered and drinkable. We recommend the use of mineral water, which can be easily obtained in any market, but public water can also be used, as long as it is filtered and boiled.



**Contact with clean, filtered water poses no known risk to the operator or patient, but the use of sanitized gloves is recommended when filling the tanks to avoid cross-contamination.**

### 10.9. Water Sample Collection Point

It is recommended to install a water sample collection point at or near the water inlet of the equipment. It consists of an outlet connection with a collection valve. Sampling and colony counting by a laboratory before installation of the equipment is recommended to ensure water quality and the absence of unacceptable microbial contamination. The microbial count should meet national standards for drinking water and should not exceed 500 CFU/mL under any circumstances. After installation, this procedure should be performed periodically, or according to national requirements.

### 10.10. Sewer Network

The sewage network must have good water slopes, and its installation should preferably be under the floor.

- Maximum flow from the sewage system: 3.5 L/min;
- Nominal pipe diameter should be Ø 40 mm;
- Minimum angle: 2°.

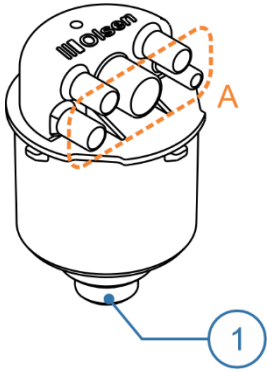

### 10.11. Amalgam Separator

For installation of the Amalgam Separator, connect the  $\frac{3}{4}$ " outlet of the Drain Connector to the inlet of the Amalgam Separator (1). The use of adapters may be required (not supplied by Olsen). The Sewer Connector concentrates all of the equipment's sewer and suction lines (A).

### 10.12. Vacuum Specifications

- Vacuum in the suction machine:
  - Min.: 50 mmHg;
  - Max.: 150 mmHg.
- Suction power:
  - Min.: 90 L/min;
  - Max.: 200 L/min.
- Suction system type 2: medium flow rate.
- Filter mesh size: 1.2 mm.

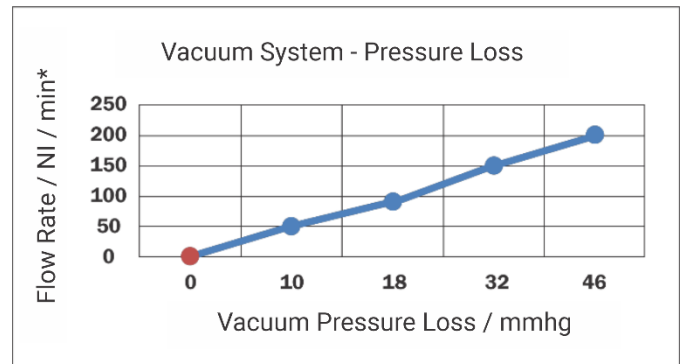

\* Pressure loss values above 200 NI/min are not shown because they are far above the pressure values specified for this equipment.



**If the vacuum reaches values greater than 150 mm Hg, a vacuum limiter (not supplied by Olsen) must be installed.**

### 10.13. Electrical Requirements

The electrical supply must comply with local regulations, have a single-phase connection, protective earthing and DR circuit breaker of 10 A and 30 mA. The circuit breaker must supply exclusively the dental equipment and must be easily and quickly accessible for disconnecting the equipment from the electrical supply. If the electrical supply presents voltage variation, it is necessary to install a voltage stabilizer.

Observe the information below for sizing the electrical installation:

Voltage (V)	Wire gauge (mm <sup>2</sup> )	Distance (m)	Current (A)
118 / 127 / 220 / 230	2.5	Up to 20	10



**All equipment leaves the factory adjusted for 220V. The voltage must be selected at the moment of installation by an accredited technician.**



**Do not connect any other equipment to the exclusive power supply network of the dental equipment.**



**This equipment must be connected only to a protective earthed electrical supply. Risk of electric shock!**

### 10.14. Check List

The following list is intended to provide important details related to the installation environment, supply conditions, and equipment installation:

- a) Did the equipment arrive as ordered and was it delivered in perfect condition?
- b) The mains voltage must be 118/127/220/230 V (according to the equipment's choice of voltage) with a tolerance of  $\pm 10\%$ . If the voltage is found to be higher than the tolerance, has a stabilizer been installed for the equipment?
- c) The electrical network must comply with local regulations, with adequate wiring and grounding for the equipment in accordance with the *Installation - Electrical Requirements* section.
- d) Is there a suitable circuit breaker to protect the equipment, in accordance with the *Installation - Electrical Requirements* section?
- e) Are the environmental conditions for using the equipment being respected?
- f) Are the water and sewage networks laid out in accordance with the *Installation - Water for the Water Unit and Sewer Network* section of this document?
- g) Is the water pressure in accordance with the value specified in the *Installation - Water for the Water Unit* section?
- h) Are the hydraulic connections in accordance with the *Installation Template*?
- i) Does the compressor and compressed air network comply with the *Electrical Installation - Compressed Air and Compressed Air Piping* section?
- j) Is there a filter with a vapor condenser in the compressed air piping to the equipment?
- k) Is the compressed air pressure in the equipment connection box within the range specified in the *Electrical Installation - Compressed Air* section?
- l) Does the compressor cycle on and off correctly?
- m) Are all the equipment controls working correctly?
- n) Have the movements of the dental light arms, water unit, working table and assistant module been checked?
- o) Does the dental light turn on, off and change intensities correctly?

## 11. PREVENTIVE MAINTENANCE PLAN

To ensure the full operation of the equipment and prevent possible problems, the Dental Equipment must undergo maintenance plan.



**Olsen recommends that maintenance plan be performed every 180 days, even after the warranty period has ended.**



**The performance of preventive or corrective maintenance by an accredited technician does not interfere with the equipment's warranty period.**



**Hydropneumatic and electrical diagrams, installation instructions, parts list, or other technical information necessary for the installation and maintenance of the equipment will be made available upon request, through our e-mail: [sat@olsen.odo.br](mailto:sat@olsen.odo.br) or by phone: (48) 2106-6000.**



**Use only genuine Olsen parts and accessories. Use of non-genuine components may compromise equipment performance, increase emissions, or reduce electromagnetic immunity.**



**Only Olsen authorized service personnel can replace the power cord and fuses in the equipment. Risk of electric shock!**



**The operator should not perform maintenance on the equipment.**



**Do not make adaptations, modifications or changes to the equipment or its components or accessories without the manufacturer's authorization.**



**Only Olsen's authorized Technical Assistant can perform scheduled and/or corrective maintenance, under penalty of loss of warranty.**

When performing preventive maintenance, the technician must register it in the Revision Register. During the revision, the technician will evaluate the general conservation status of the equipment, as well as monitor the wear of the components and if there is need for lubrication.

## 11.1. Maintenance of Electrical and Mechanical Parts

The table below lists the items that should be checked by the Olsen authorized service technician:

<b>CHAIR/FOOT CONTROL</b>
Checking the foot controls and movements
Checking the motors and joints
Checking the propulsion of foot control valve
Automatic Drain Valve Check
Checking air, water, and particulate filters
<b>WORKING TABLE</b>
Checking the table flex arm joints and air brake
Caster check (Kart System)
Check pressure and coupling rings
Checking valves, vanes and tip holders
Insert wear check (ultrasonic)
Checking the Blue Touch Panel Controls
Checking and lubricating the syringe buttons
<b>WATER UNIT/ASSISTANT MODULE</b>
Checking arm and module joints
Venturi suction check
Lubrication of the debris separator filter rings
Disassembling, cleaning and lubricating the bowl ring
Checking the vanes of the tip carriers
Verification of the panel controls
Prophy-jet system/prophylaxis system check
Disassembling and lubricating syringe barrel buttons
<b>DENTAL LIGHT</b>
Checking joint movements
Checking focus and intensities
<b>DENTAL STOOL</b>
Checking the casters
Checking the piston and movements
<b>CURING LIGHT</b>
Verification of intensity and operation programs
Tip and support ring check
<b>CONNECTION BASE/BOX</b>
Checking the electrical, water supply, air, and vacuum connections
Checking the drain connection (baffle)

## 11.2. Troubleshooting Table

If in doubt or if you notice a problem with the equipment that is not mentioned in this chapter, stop using the equipment immediately and contact Olsen authorized service personnel.

Item	Problem	Causes	Solutions
1	The chair doesn't perform any command	a) Equipment is not connected to the mains; b) Mains circuit breaker is off; c) Lack of electricity power; d) Protection fuse is blown; e) Emergency key is activated.	a) Connect the equipment to the mains power; b) Turn on the mains power circuit breaker; c) Contact your local power company; d) Contact Olsen authorized service personnel; e) Deactivate the emergency key
2	Chair does not memorize work position	a) Equipment is not connected to the mains; b) Command saved is incorrect; c) Electronic problem.	a) Check causes and solutions from item 1; b) Check the operation in the manual; c) Contact Olsen authorized service.
3	Flex arm does not lock the table in position	a) Compressor is not working properly; b) Pneumatic or capacitive sensor problem.	a) Call the compressor service; b) Contact Olsen authorized service.
4	Dental light does not turn on	a) Equipment is not connected to the mains; b) The LED is burnt out; c) Blown fuse or component rupture.	a) Check causes and solutions from item 1; b) Contact Olsen authorized service; c) Contact Olsen authorized service.
5	Micromotor/turbine doesn't work or is weak	a) Instrument ducts are clogged; b) Slack in the instrument coupling; c) Air register is not completely open; d) Insufficient air pressure for the equipment; e) Compressor is not working correctly; f) Blockage in the pneumatic system;	a) Lubricate the instrument's ducts; b) Couple the instrument correctly; c) Open the air register of the equipment; d) Open the air supply register; e) Call compressor service; f) Contact Olsen authorized service.
6	Pneumatic handpiece has water leakage on the coupling	a) Slack in instrument coupling; b) The instrument seal is worn out; c) Gasket does not seal the instrument properly; d) Coupling is worn.	a) Couple the instrument correctly; b) Replace the gasket; c) Apply original instrument seal; d) Contact Olsen authorized service.
7	Pneumatic handpiece doesn't have water on the spray	a) Coupling water adjustment is closed; b) Water tank is empty; c) Instrument coupling slack; d) Air register not fully open; e) Insufficient air pressure to the instrument; f) Blockage in the hydropneumatic system.	a) Align the green points of the coupling; b) Fill the reservoir with water; c) Couple the instrument correctly; d) Open the air register of the equipment; e) Open the air supply register; f) Contact Olsen authorized service.
8	Saliva ejector is weak or loses suction during the procedure	a) The ejector filter is clogged; b) Insufficient air pressure to the equipment; c) Drain hose obstruction; d) Clogged drain; e) Blockage in the hydropneumatic system.	a) Clean the ejector filter; b) Open the air supply register; c) Release bent/flashed hose; d) Have the drain unblocked; e) Contact Olsen authorized service.
9	Curing light isn't working	a) Power supply problem; b) Blockage of 10 consecutive drives; c) Possible overheating of the curing light.	a) Check causes and solutions of item 1; b) Wait 20 seconds and restart; c) Contact Olsen authorized service.
10	Scaler vibrates little or nothing	a) Power supply problem; b) Tip not properly attached to transducer; c) Tip worn or defective scaler.	a) Check causes and solutions of item 1; b) Install the probe with the probe wrench; c) Contact Olsen authorized service.
11	Scaler is overheating	a) Power incompatible with the tip used; b) Tip badly coupled to the transducer; c) Tip with wear or defect in the scaler.	a) Adjust the power according to the tip in use; b) Install the probe with the probe wrench; c) Contact Olsen authorized service.
12	Scaler has little or no water	a) The water tank is empty; b) Scaler water damper is closed; c) Clogging in the transducer.	a) Fill the tank with water; b) Open the scaler water register; c) Contact Olsen authorized assistance.

13	Turbine's optical fiber light doesn't work	a) The equipment is not connected to the electric power; b) Fiber optic button is off; c) The instrument is not properly coupled; d) Pneumatic or electronic problem.	a) Check causes and solutions of item 1; b) Turn on the fiber optic light switch; c) Couple the instrument correctly; d) Contact Olsen authorized service.
14	Electrical micromotor doesn't work or it's malfunctioning	a) Equipment is not connected to the mains; b) Pneumatic instruments do not work; c) Rotation selector switch is in the Off position; d) Speed control is at minimum power; e) Electrical or pneumatic problem.	a) Check causes and solutions of item 1; b) Check causes and solutions of item 5; c) Select a direction of rotation; d) Increase the speed on the control; e) Contact Olsen authorized service.

### 11.3. Installation and Maintenance Registration

For your control, record here the dates of the equipment's installation and maintenance plan:

## INSTALLATION

Service Order No.: \_\_\_\_\_

Date: \_\_\_\_\_

Technical Assist.: \_\_\_\_\_

Technician: \_\_\_\_\_

## REVIEW - 6 MONTHS

Service Order No.: \_\_\_\_\_

Date: \_\_\_\_\_

Technical Assist.: \_\_\_\_\_

Technician: \_\_\_\_\_

### 12. DISPOSAL



Debris, residues and infectious materials resulting from the procedures performed on this equipment must be deposited in biological waste duly identified and in accordance with current legislation.



For proper disposal of this equipment and its components and accessories, we recommend that it be sent to specialized recycling companies to ensure the best destination of each component without harm to the environment.





The disposal of this equipment and its components and accessories must be done in accordance with the local legislation in force.

### 13. ELECTROMAGNETIC COMPATIBILITY (EMC)

 The Olsen’s Dental Unit needs special attention regarding electromagnetic compatibility and must be installed and put into use in accordance with the electromagnetic compatibility information presented in this chapter.

 Radio Frequency (RF) communication equipment, portable and mobile, can affect the Olsen’s Dental Unit.

 Caution: This equipment is not suitable for use in a residential environment and may not provide adequate radio frequency protection in such an environment.

 The only essential performance of this equipment is to deliver at least 15,000 lux of maximum dental light luminance. If this performance is lost due to electromagnetic interference, stop operation of the equipment and contact authorized service personnel.

 Do not install or use any electrical equipment on or near the dental chair. If necessary, the dental chair should be observed to verify that it is functioning normally in the configuration in which it will be used.

 Do not use accessories, transducers, internal parts of components, and other cables other than those specified. Use of unsuitable components may result in increased emission or decreased electromagnetic immunity, resulting in improper operation.

 Portable RF communications equipment (including peripherals such as antenna cables and external antennas) should not be used closer than 12 inches (30 cm) to any part of the equipment, including cables specified by the manufacturer. Failure to do so may result in degradation of performance of this equipment.

**Guidance and Manufacturer's Declaration - Electromagnetic Emissions  
Test Levels According to IEC 60601-1-2**

The Olsen’s Dental Units are intended for use in the electromagnetic environment specified below. The customer or the user of the Olsen’s Dental Units should assure that it is used in such an environment.

Emission Test	Test Level	Compliance	Electromagnetic Environment – Guidance
RF emissions IEC/CISPR 11	Group 1	Group 1	Dental Chairs use RF energy only for their internal functions. Therefore, its RF emissions are extremely low and are unlikely to cause any interference in nearby electronic equipment.
RF emissions IEC/CISPR 11	Class A	Class A	Dental Chairs are suitable for use in all establishments, except domestic ones and those directly connected to the public low voltage power supply network that powers buildings used for domestic purposes.
Harmonic emissions IEC 61000-3-2	Class A	Class A	
Voltage fluctuation / Scintillation emissions IEC 61000-3-3	Class A	Class A	

**Guidance and Manufacturer's Declaration - Electromagnetic Immunity**

The Olsen's Dental Units are intended for use in the electromagnetic environment specified below. The customer or the user of the Olsen's Dental Units should assure that it is used in such an environment.

Phenomenon	Basic EMC Standard or Test Method	Immunity Test Level	Compliance Level
Electrostatic discharge	IEC 61000-4-2	± 8 kV contact	± 8 kV contact
		± 2 kV, ± 4 kV, ± 8 kV, ± 15 kV air	± 2 kV, ± 4 kV, ± 8 kV, ± 15 kV air
Radiated RF EM fields	IEC 61000-4-3	3 V / m 80 MHz - 2.7 GHz 80% AM at 1 kHz	3 V / m 80 MHz - 2.7 GHz 80% AM at 1 kHz
Fields in the vicinity from RF wireless communications equipment	IEC 61000-4-3	According to Table 9 of IEC 60601-1-2	According to Table 9 of IEC 60601-1-2
Electrical fast transients/bursts	IEC 61000-4-4	± 2 kV 100 kHz repetition frequency	± 2 kV 100 kHz repetition frequency
Surges line-to-line	IEC 61000-4-5	± 0.5 kV, ± 1 kV	± 0.5 kV, ± 1 kV
Surges line-to-ground	IEC 61000-4-5	± 0.5 kV, ± 1 kV, ± 2 kV	± 0.5 kV, ± 1 kV, ± 2 kV
Conducted disturbances induced by RF fields	IEC 61000-4-6	3 V 0.15 MHz - 80 MHz 6 V in ISM bands between 0.15 MHz and 80 MHz 80% AM at 1 kHz	3 V 0.15 MHz - 80 MHz 6 V in ISM bands between 0.15 MHz and 80 MHz 80% AM at 1 kHz
Magnetic fields at the stated feed frequency	IEC 61000-4-8	30 A/m 50 Hz or 60 Hz	30 A/m 50 Hz or 60 Hz
Voltage dips	IEC 61000-4-11	0% UT; 0,5 cycle At 0°, 45°, 90°, 135°, 180°, 225°, 270° and 315°	0% UT; 0,5 cycle At 0°, 45°, 90°, 135°, 180°, 225°, 270° and 315°
		0% UT; 1 cycle and 70% UT; 25/30 cycle Single phase: at 0°	0% UT; 1 cycle and 70% UT; 25/30 cycle Single phase: at 0°
Voltage interruptions	IEC 61000-4-11	0% UT; 250/300 cycles	0% UT; 250/300 cycles
Proximity magnetic fields	IEC 61000-4-39	According to Table 11 of IEC 60601-1-2	According to Table 11 of IEC 60601-1-2

**NOTE 1:** UT is the AC mains voltage before applying the test level.

**NOTE 2:** At 80 MHz and 800MHz, the higher frequency range is applicable.

**NOTE 3:** These guidelines may not apply in all situations. Electromagnetic propagation is affected by absorption and reflection from structures, objects and people.

Recommended separation distance according to transmitter frequency (Table 9, IEC 60601-1-2)				
Test frequency (MHz)	Band (MHz)	Service	Modulation	Immunity Test Level (V/m)
385	380 -390	TETRA 400	Pulse modulation 18 Hz	27
450	430 - 470	GMRS 460, FRS 460	FM ± 5 kHz deviation 1 kHz sine	28
710	704 - 787	LTE Band 13, 17	Pulse modulation 217 Hz	9
745				
780				
810	800 - 960	GSM 800/900, TETRA 800, iDEN 820, CDMA 850, LTE Band 5	Pulse modulation 18 Hz	28
870				
930				
1 720	1 700 - 1990	GSM 1800; CDMA 1900; GSM 1900; DECT; LTE Band 1, 3, 4, 25; UMTS	Pulse modulation 217 Hz	28
1 845				
1 970				
2 450	2 400 - 2570	Bluetooth, WLAN, 802.11 b/g/n, RFID 2450, LTE Band 7	Pulse modulation 217 Hz	28
5 240	5100 - 5800	WLAN 802.11 a/n	Pulse modulation 217 Hz	9
5 500				
5 785				

Test levels for magnetic fields in proximity (Table 11, IEC 60601-1-2)		
Test frequency	Modulation	Immunity test level (A/m)
134,2 kHz	Pulse modulation 2,1 kHz	65
13,56 MHz	Pulse modulation 50 kHz	7,5

## 14. ADVERSE EVENT REPORTING

In the event of adverse events or technical complaints related to the product, Olsen Industria e Comercio S.A. must be notified through the following channels:

- Olsen: [sac@olsen.odo.br](mailto:sac@olsen.odo.br) ou [sat@olsen.odo.br](mailto:sat@olsen.odo.br)

## 15. WARRANTY

### DEAR CUSTOMER,

Congratulations on purchasing an Olsen product, a brand recognized for its durability and reliability. We are pleased to present the terms and conditions of our product warranties for your peace of mind and safety.

### CLAUSE 1 - LEGAL GUARANTEE

In accordance with local regulations, all Olsen products have a legal guarantee of 90 days from the date of issue of the sales invoice. During the legal warranty period, the following are covered: parts (see exclusions below), technical service and technician travel.

### CLAUSE 2 - EXTENSION OF THE LEGAL GUARANTEE (CONDITIONAL)

Olsen may extend the warranty on its products to up to 1 year (after installation) if the conditions described below are met. This additional 90-day warranty is for parts only, excluding labor and technician travel.

#### a) Dental equipment;

Must be installed by an Olsen accredited technician, within 90 days of the invoice being issued - In this case, the warranty period starts to run from the date of installation;

They must be checked by an Olsen-accredited technician within 180 days of installation (tolerance of 10 days less and 10 days more);

Failure to carry out the review within 180 days of installation will result in the suspension of the warranty, i.e. only a 6-month extended warranty;

All technical assistance must be recorded on an Olsen service order, signed by the technician and the customer;

#### b) Veterinary, medical, peripherals and accessories;

1 year from issue of the invoice.

### CLAUSE 3 - INCLUSION OF GUARANTEES

Proven product manufacturing defects;

Within the 90-day legal guarantee - Parts, services and travel

Within the extended warranty of 6 months (when covered) - Parts only

Within the 1-year extended warranty (when covered) - Parts only

### CLAUSE 4 - WARRANTY EXCLUSIONS

Faults or defects arising from: misuse, negligence, recklessness, malpractice, faulty handling, failure to observe the instructions for use, maintenance not carried out, lack of lubrication, failure to carry out the cleaning procedures contained in the product manual;

Lamps, reflector mirrors and fuses;

Falls, knocks, improper transportation and storage;

Action by natural agents;

Installation of the dental chair in a location other than that stated on the Installation Service Order;

Accidents of any kind;

Application of chemical products not indicated in the product manual;  
Alteration of any kind to the original characteristics of the product;  
Use for purposes other than those for which the product is intended;  
Contact of the equipment with materials (fabrics, leather, disposable gloves, paints, detergents, pigments, cutting or piercing objects, etc.) that could alter its original characteristics;  
Connection to the mains with a voltage incompatible with that of the equipment and without adequate grounding;  
Electrical, pneumatic, hydraulic and sewage infrastructure in disagreement with the owner's manual and local standards.  
Failure to comply with the technicians' instructions and recommendations when maintenance is required;

### **CLAUSE 5 - WARRANTY WILL EXPIRE OR CEASE:**

By the natural expiry of its validity period;  
Alterations to the equipment not authorized in writing by Olsen;  
By tampering with the Service Order or filling it in incorrectly;  
Installation, technical assistance or scheduled overhaul carried out by personnel not authorized by Olsen;  
The use of non-original Olsen spare parts;

### **CLAUSE 6 - GENERAL CONDITIONS**

The repair or replacement of parts during the warranty period will not extend the original period of validity of the warranty;  
The right to claim for apparent or easily ascertainable defects expires 90 (ninety) days after the invoice is issued;  
The customer is responsible for contacting the accredited technical team to analyze the problem and repair it, and Olsen provides all the contacts of the accredited technicians on its digital platforms for the customer to choose from;  
The warranty will be activated through Olsen's network of accredited technicians, and the customer is responsible for contacting them, who will analyze whether or not the warranty is valid (following the above criteria);  
Olsen products are registered with the regulatory agency and therefore have to meet various regulatory requirements. Neither the customer nor Olsen are authorized to de-characterize their equipment in breach of the registration;  
It is the customer's responsibility to pay for the installation and scheduled overhaul of the product, and for the travel and accommodation of the technicians involved in answering calls for installation, scheduled overhaul and maintenance of the equipment;  
The customer, after checking the services carried out in the installation and overhaul of the equipment, must date and sign the service order provided by the technician and keep it with his or her records.

## 16. MESSAGE FROM THE PRESIDENT

**Olsen and clients:  
A successful relationship.**

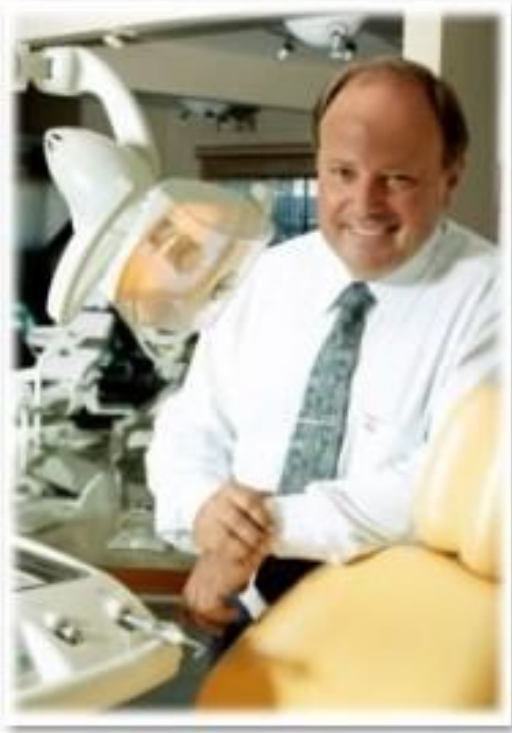

I linked my name to the factory and to the dental and medical equipment that we currently produce and sell in more than 100 countries, aware of my responsibilities and the return of this attitude over time.

Our equipment is modern, innovative, durable and very low maintenance cost. These qualities were achieved through a competent and dedicated team, of which I am proud in every aspect, willing to bring our customers the best of our creative ability.

The company will always be available to all those who have preferred us when purchasing Olsen products, for any and all information, technical assistance and especially comments relevant to the relationship, which we hope will always bring satisfaction, providing more and more profitable business for all.

Cesar Olsen

[This page has been intentionally left blank]

[This page has been intentionally left blank]

[This page has been intentionally left blank]

# ***/// Olsen***



**Olsen Indústria e Comércio S/A**

Rua Romalino João da Rosa, 11 – CEIP – Brejaru

CEP 88133-516 – Palhoça/SC – Brazil

Tel.: +55 (48) 2106-6000

[www.olsen.odo.br](http://www.olsen.odo.br)